

# **Agilent E2094M IO Libraries**

## **Agilent IO Libraries Installation and Configuration Guide**



**Agilent Technologies**

# Notices

© Agilent Technologies, Inc. 2003

No part of this manual may be reproduced in any form or by any means (including electronic storage and retrieval or translation into a foreign language) without prior agreement and written consent from Agilent Technologies, Inc. as governed by United States and international copyright laws.

## Manual Part Number

E2094-91003

## Edition

Eighth edition, April 2003

Printed in USA

Agilent Technologies, Inc.  
815 West 14th Street  
Loveland, CO 80537 USA

## Warranty

**The material contained in this document is provided “as is,” and is subject to being changed, without notice, in future editions. Further, to the maximum extent permitted by applicable law, Agilent disclaims all warranties, either express or implied, with regard to this manual and any information contained herein, including but not limited to the implied warranties of merchantability and fitness for a particular purpose. Agilent shall not be liable for errors or for incidental or consequential damages in connection with the furnishing, use, or performance of this document or of any information contained herein. Should Agilent and the user have a separate written agreement with warranty terms covering the material in this document that conflict with these terms, the warranty terms in the separate agreement shall control.**

## Technology Licenses

The hardware and/or software described in this document are furnished under a license and may be used or copied only in accordance with the terms of such license.

## Restricted Rights Legend

If software is for use in the performance of a U.S. Government prime contract or subcontract, Software is delivered and licensed as “Commercial computer software” as defined in DFAR 252.227-7014 (June 1995), or as a “commercial item” as defined in FAR 2.101(a) or as “Restricted computer software” as defined in FAR 52.227-19 (June 1987) or any equivalent agency regulation or contract clause. Use, duplication or disclosure of Software is subject to Agilent Technologies’ standard commercial license terms, and non-DOD Departments and Agencies of the U.S. Government will receive no greater than Restricted Rights as defined in FAR 52.227-19(c)(1-2) (June

1987). U.S. Government users will receive no greater than Limited Rights as defined in FAR 52.227-14 (June 1987) or DFAR 252.227-7015 (b)(2) (November 1995), as applicable in any technical data.

## Safety Notices

### CAUTION

A **CAUTION** notice denotes a hazard. It calls attention to an operating procedure, practice, or the like that, if not correctly performed or adhered to, could result in damage to the product or loss of important data. Do not proceed beyond a **CAUTION** notice until the indicated conditions are fully understood and met.

### WARNING

A **WARNING** notice denotes a hazard. It calls attention to an operating procedure, practice, or the like that, if not correctly performed or adhered to, could result in personal injury or death. Do not proceed beyond a **WARNING** notice until the indicated conditions are fully understood and met.

# Agilent I/O Libraries Installation Guide for Windows

## 1 Getting Started

Getting Started	8
Obtaining the Latest IO Libraries Information	8
Introducing the Agilent IO Libraries	8
IO Libraries Components	9
Steps to Using the Agilent IO Libraries	10
Pre-Installation Checks	12

## 2 Installing the Agilent IO Libraries

Installing the Agilent IO Libraries	16
Runtime and Full Installation Packages	16
Selecting the Type of Installation	21
Installing a Full Version of New Libraries	22
Installing a Runtime Version of New Libraries	35
Installing a Custom Version of New Libraries	49
Installing IO Interfaces	69
Configuring IO Interfaces	74
Programming via IO Interfaces	74
Upgrading Existing Libraries	75
Installing the IO Libraries	75
Installing IO Interfaces	78
Configuring IO Interfaces	84
Programming via IO Interfaces	84
Maintaining Existing Libraries	85
Modifying Existing Libraries	85
Repairing Existing Libraries	88
Removing Existing Libraries	91

### **3 Agilent IO Libraries Description**

Agilent IO Libraries Description	96
Agilent IO Libraries Components	96
Agilent VISA Description	96
Agilent SICL Description	98
IO Config Description	99
VISA Assistant Description	100
VXI Resource Manager Description	100
LAN Server Description	101
Agilent IO Libraries Items Created	102
Agilent IO Libraries Control Icon	102
Program Groups Created	112
Access to Previous Versions	112
Agilent IO Libraries System Information	115
Minimum System Requirements	115
Agilent IO Libraries Supported Interfaces	116
Agilent IO Libraries Revisions	118

### **4 Using IO Configuration Utilities**

Using IO Configuration Utilities	122
Getting Started	122
Using IO Config	123
Using VISA Assistant	129
Using the ViFind32 Debug Utility	132
Using the VXI Resource Manager	134
Using the LAN Server	137

### **5 Configuring IO Interfaces**

Configuring IO Interfaces	140
Introduction to IO Interface Configuration	140
Configuring GPIB Interfaces	141

Configuring VXI Interfaces	152
Configuring USB Interfaces	161
Configuring LAN Interfaces	172
Configuring ASRL Interfaces	203



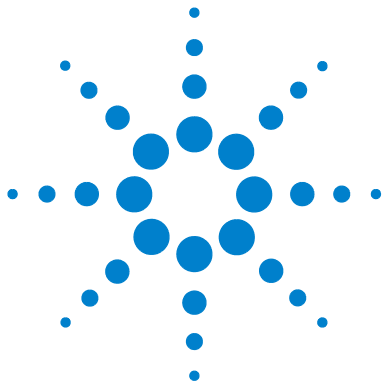

# 1 Getting Started



## Getting Started

This chapter details suggested steps to installing the Agilent IO Libraries on PCs with Windows 98SE, Windows Me, Windows 2000, Windows XP, and Windows NT 4.0 operating systems, including:

- Obtaining the Latest IO Libraries Information
- Introducing the Agilent IO Libraries
- Pre-Installation Checks

### Obtaining the Latest IO Libraries Information

Due to the continuing improvement and enhancement of the Agilent IO Libraries, printed and electronic manuals may not always contain the most current information. Use the following links to obtain the latest IO Libraries documentation:

- You can download the latest Agilent IO Libraries version from:

<http://www.agilent.com/find/adniolib>

- For the latest Agilent IO Libraries troubleshooting information, you can look in the *Instrument I/O | IO Libraries Troubleshooting* section of the Agilent Developer Network (ADN) Knowledge Library at:

<http://www.agilent.com/find/adnknowledge>

- For notes, patches, and bug fixes, explore the Agilent IO Libraries support web page at:

[http://www.agilent.com/find/iolib\\_support](http://www.agilent.com/find/iolib_support)

### Introducing the Agilent IO Libraries

This section introduces the Agilent IO Libraries, including IO Libraries components and steps to using the libraries.



## IO Libraries Components

The Agilent IO Libraries software consists of two libraries and four IO configuration utilities, plus an IO Libraries Control, as shown in the following table. See [Chapter 3](#), “Agilent IO Libraries Description” for a full description of the Libraries.

**Table 1** IO Library Components

IO Libraries	Description
Agilent VISA	<i>Agilent Virtual Instrument Software Architecture (VISA)</i> is an IO library that can be used to develop I/O applications and instrument drivers that comply with the <i>VXIplug&amp;play</i> standards.
Agilent SICL	<i>Agilent Standard Instrument Control Library (SICL)</i> is an IO library developed by Agilent that is portable across many I/O interfaces.
<b>IO Configuration Utilities</b>	
IO Config	The IO Config utility is used by the Agilent IO Libraries to configure instrument I/O hardware interfaces. An interface must be configured with IO Config before it can be used with the Agilent IO Libraries.
VISA Assistant	VISA Assistant is an application program that can be used to control and communicate with VXI, GPIB, and Serial instruments.
ViFind32	ViFind32 is a debug utility that lists, in a console window, all VISA resources found.
VXI Resource Manager	If your system includes an E8491 IEEE-1394 PC Link to VXI interface, you can view the output of the VXI Resource Manager to determine if your system is properly configured.

**Table 1** IO Library Components

IO Libraries	Description
<b>Agilent IO Libraries Control (blue IO Icon on the Windows Taskbar)</b>	
Clicking the blue <b>IO</b> icon allows you to:	Run the VISA Assistant IO configuration utility Run the ViFind32 debug utility Run the IO Config utility Display online documentation and Help files Run the Windows Event Viewer Select Agilent VISA Options Hide the Icon or Exit View the Version of the Agilent IO Libraries

### Steps to Using the Agilent IO Libraries

The following figure shows a suggested sequence to using the Agilent IO Libraries.

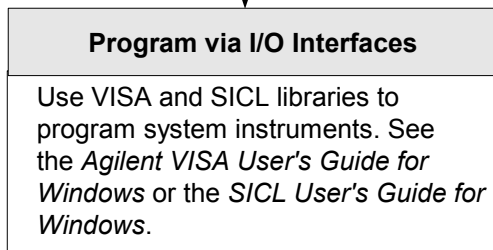
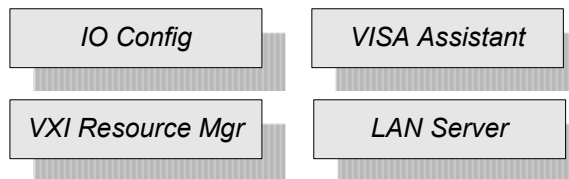
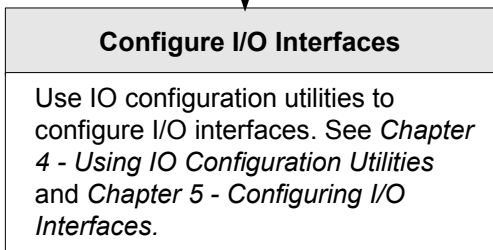
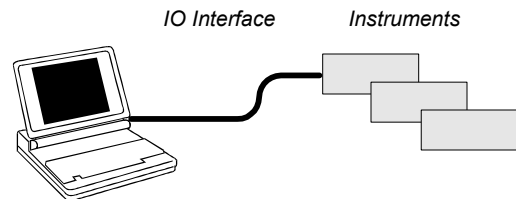
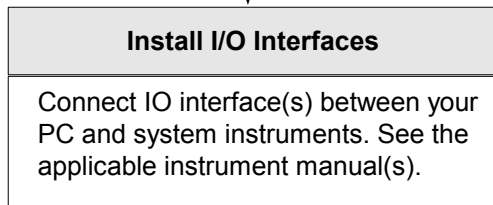
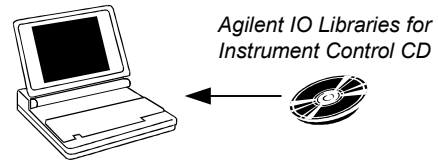
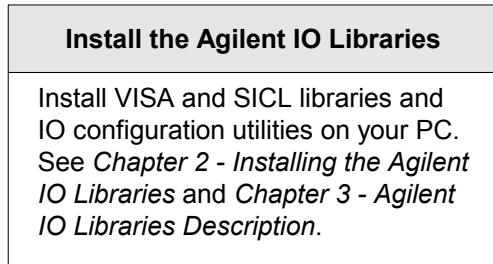

VISA: viOpen (... "GPIB0::5::INSTR" ...)  
SICL: iopen ("gpib0,5")

## Pre-Installation Checks

Before you install the Agilent IO Libraries on your PC, you should:

- Check System Requirements
- Create an Emergency Repair Disk
- Check for Installed IO Libraries

### Checking System Requirements

See the following table to verify that your system meets the minimum requirements and that your system interfaces are supported. This table summarizes **minimum** hardware and software requirements to install and use the Agilent IO Libraries. Adding additional RAM may improve overall system performance.

**Table 2** System Requirements

Item	Minimum Requirements
<b>Hardware Requirements</b>	
PC Operation/Memory	100 MHz operation and 64 Mb RAM
Microsoft Windows Compatible	With available slot for purchased hardware
<b>Software Requirements</b>	
Operating System	Windows 98SE/Me/2000/XP Home and Professional/NT 4.0
IO Library Installation Sizes	<ul style="list-style-type: none"> <li>- Runtime Installation: 24 Mb</li> <li>- Full Installation (without manuals): 29 Mb</li> <li>- Full Installation (with manuals): 45 Mb</li> <li>- Add Adobe Acrobat Reader (version 5.05): 16 Mb additional</li> </ul>

## Creating an Emergency Repair Disk

The Agilent IO Libraries include IO drivers for various PCI plug-in cards. Extensive testing of these drivers and cards has revealed that early revisions of the BIOS code in several PCs are not completely PCI-compliant. This has caused problems when running the Agilent IO Libraries, whether or not the PCI card is installed. Problems can include system errors, operating system crashes, or card initialization failures.

For Windows NT operating systems, most PC manufacturers recommend that before installing any PCI card, you first create an EMERGENCY REPAIR DISK. If your PC exhibits any abnormal behavior following installation of the Agilent IO Libraries, Agilent recommends a BIOS upgrade to the PC. BIOS Upgrades are available from most PC manufacturers' websites.

## Checking for Installed Agilent IO Libraries

If a version of the Agilent IO Libraries has been installed, a blue **IO** icon may be displayed on the Windows taskbar. If so, click the icon and click **About Agilent IO Libraries Control** to display the installed version.



- If the IO icon is not displayed, a version may still be installed. To check this, click **Start > Programs** and look for the Agilent IO Libraries program group.
- If this group is displayed, click **Agilent IO Libraries > IO Control** to display the **IO** icon. Then, click the icon and select **About Agilent IO Libraries Control** to display the installed version.
- If the Agilent IO Libraries program group is missing or empty, no Agilent IO Libraries are installed.

If a version of the Agilent IO Libraries is installed, go to “Upgrading Existing Libraries” in [Chapter 2](#), “Installing the Agilent IO Libraries.” If no Agilent IO Libraries are installed, go to “Selecting the Type of Installation” in Chapter 2.

## **1 Getting Started**

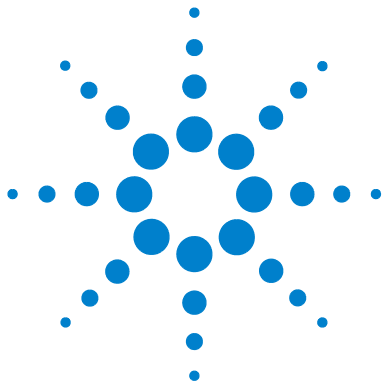

## 2 Installing the Agilent IO Libraries



# Installing the Agilent IO Libraries

This chapter shows how to install the Agilent IO Libraries on PCs with Windows 98SE, Windows Me, Windows 2000, Windows XP, or Windows NT 4.0 operating systems. The chapter contents are:

- Runtime and Full Installation Packages
- Selecting the Type of Installation
- Installing a Full Version of New Libraries
- Installing a Runtime Version of New Libraries
- Installing a Custom Version of New Libraries
- Upgrading Existing Libraries
- Maintaining Existing Libraries

## Runtime and Full Installation Packages

There are two types of Agilent IO Libraries installation packages: **Runtime Installation** and **Full Installation**.

### Runtime Installation Package

The Runtime Installation Package can install *only* the runtime components of the Agilent IO Libraries.

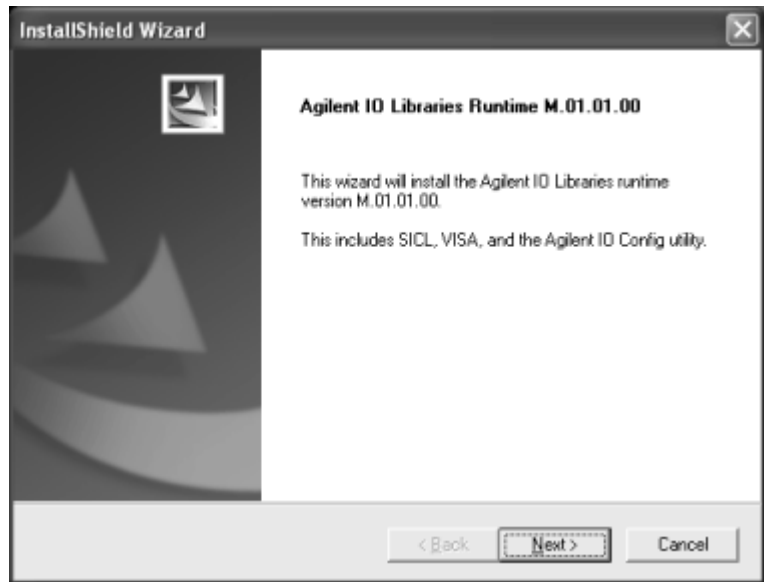

**NOTE**

Do not confuse the “Runtime” installation *option* in the Full Installation Package with the Runtime Installation Package. If, from a Full Installation Package, you select the “Runtime” install option, you will install only the Runtime components of the IO Libraries. You can later re-run the installation package to modify the set of installed components to include the Development components. The Runtime Installation Package can install *only* the runtime components of the Agilent IO Libraries.

- When the Runtime components are installed, you can run existing programs that use the Agilent IO Libraries to communicate with instruments on any of the supported interfaces (e.g. GPIB, RS-232, USB, LAN, etc.), but you cannot develop new programs that use the Agilent IO Libraries.
- The Runtime package does not install the header and library files needed to compile programs that link to the Agilent IO Libraries, so it cannot be used for developing new IO programs.

## 2 Installing the Agilent IO Libraries

- The only documentation supplied with the Runtime Installation Package is the *IO Libraries Installation Guide* and the *IO Libraries Readme* file.

## Full Installation Package

The Full Installation Package can install *both* the Runtime and Development components of the Agilent IO Libraries.

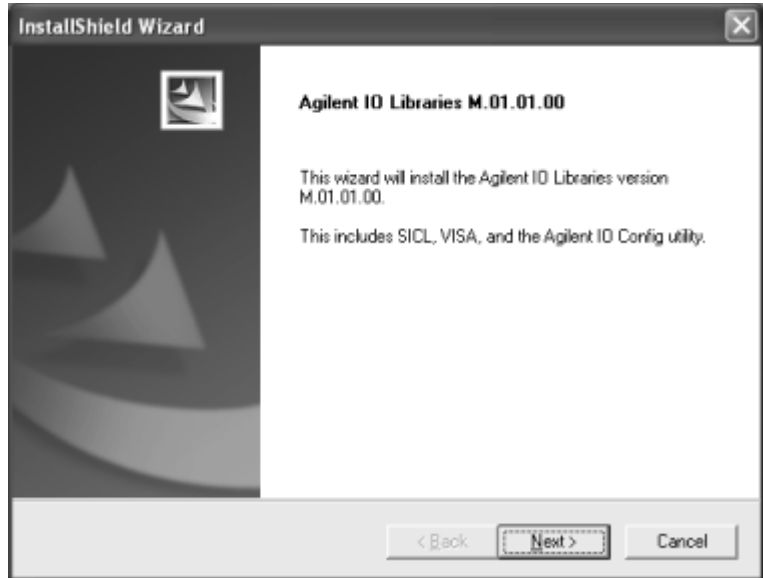

- A Full installation allows you to run programs that use the Agilent IO Libraries to communicate with instruments and also to develop your own IO programs.
- The Full package also includes a LAN server program that can be used to allow remote access over LAN to the instruments on your PC.

### NOTE

Do not confuse the “Runtime” installation option in the Full Installation Package with the Runtime Installation Package. If, from a Full Installation Package, you select the “Runtime” install option, you will install only the Runtime components of the IO Libraries. You can later re-run the installation package to modify the set of installed components to include the Development components. The Runtime Installation Package can install *only* the runtime components of the Agilent IO Libraries.

## 2 Installing the Agilent IO Libraries

If you are **upgrading** an installation from Runtime to Full, you must uninstall the Runtime installation before installing the Full installation. You must also uninstall the existing IO Libraries when going from a Full installation back to a Runtime installation or when going back to an earlier revision of the IO Libraries. The IO Libraries installer will warn you if you attempt to do this.



If the IO Libraries are already installed, you can click the blue **IO** icon on the taskbar and view the **About Agilent IO Libraries Control** information to determine if a Full or a Runtime package is installed.



The “**(Runtime)**” following the version number will be present if the IO Libraries was installed from a Runtime Installation Package. The **(Runtime)** label will not appear if the IO Libraries was installed from a Full Installation Package.



## Selecting the Type of Installation

For new Agilent IO Libraries, you can install a Full version, a Runtime version, or a Custom version of the libraries. See the following table for guidelines to choosing an installation option.

### NOTE

If another vendor's VISA is detected during installation, Agilent VISA is installed as a secondary (side-by-side) VISA to the other vendor's VISA. In this case, the other vendor's VISA is the primary VISA.

This means your applications may not be able to access instruments, as applications normally link to the primary VISA. However, some Agilent VISA utilities such as *vifind32.exe* and *VISA Assistant* use Agilent VISA even if another vendor's VISA is installed as primary VISA.

If another vendor's VISA is installed and you want to make Agilent VISA the primary VISA, you must select a Custom Installation.

**Table 3** Installation Types

Option	Description	See:
Full Installation	Installs SICL and Agilent VISA as primary VISA with the default options for your computer configuration. Installing this option allows development and runtime capabilities using SICL and Agilent VISA for all supported interfaces. Note that if you have the Runtime Installation Package, the Full Installation option is not available.	“Installing a Full Version of New Libraries”
Runtime Installation	Installs SICL and runtime Agilent VISA as primary VISA with the default options for your computer configuration. The Runtime version of IO Libraries can be installed with either the Runtime Installation Package, or by selecting the <b>Runtime Installation</b> option from the Full Installation Package. This option allows runtime capabilities (not program development) using SICL and Agilent VISA for all supported interfaces.	“Installing a Runtime Version of New Libraries”
Custom Installation	Allows you to perform a custom installation of Agilent IO Libraries components. Six options are available: <ol style="list-style-type: none"> <li>1 Full install with Agilent VISA as primary</li> <li>2 Full install with Agilent VISA as secondary</li> <li>3 Runtime install with Agilent VISA as primary</li> <li>4 Runtime install with Agilent VISA as secondary</li> <li>5 Install Agilent GPIB-VXI</li> <li>6 Select individual components</li> </ol>	“Installing a Custom Version of New Libraries”

### Installing a Full Version of New Libraries

This section shows how to install a full version of new Agilent IO Libraries, including:

- Installing the IO Libraries
- Installing IO Interfaces

- Configuring IO Interfaces
- Programming via IO Interfaces

### Installing the IO Libraries

This section provides details for performing a full installation of new Agilent IO Libraries, when Agilent IO Libraries have **not** been installed on your PC. The full installation installs all library components with recommended options for your computer and is applicable for most applications.

- 1 Turn the PC ON and, as required, install application software such as C/C++, VEE, etc. on your PC.
- 2 Insert the *Agilent IO Libraries for Instrument Control* CD into the CD-ROM drive and wait a few seconds for the application to run.
- 3 The installer should automatically start when the CD is inserted. If not, select **Start | Run** and type `<drive>:setup.exe`, where “drive” is your CD-ROM drive.
- 4 The InstallShield® Wizard appears and the Agilent IO Libraries installation begins.

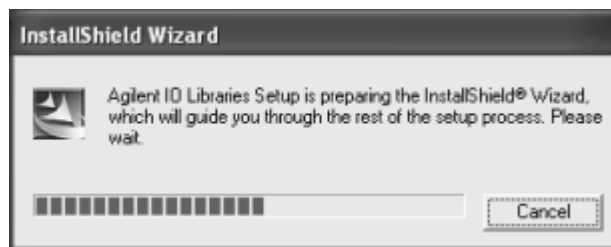

- 5 After a few seconds, the Title Screen appears.

## 2 Installing the Agilent IO Libraries

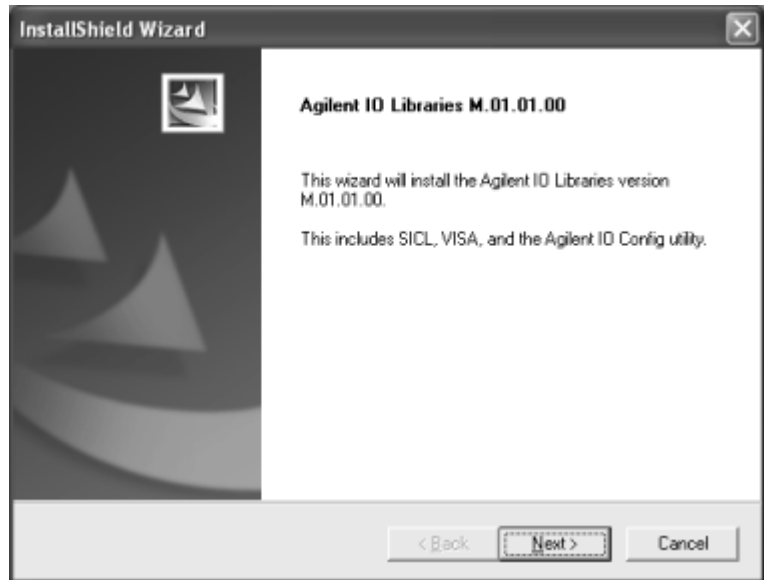

- 6 From the Title Screen, click **Next>** to go to the **License Agreement** screen. After reviewing the licensing agreement, click **Yes** to accept the license terms and display the **Readme Information** screen.



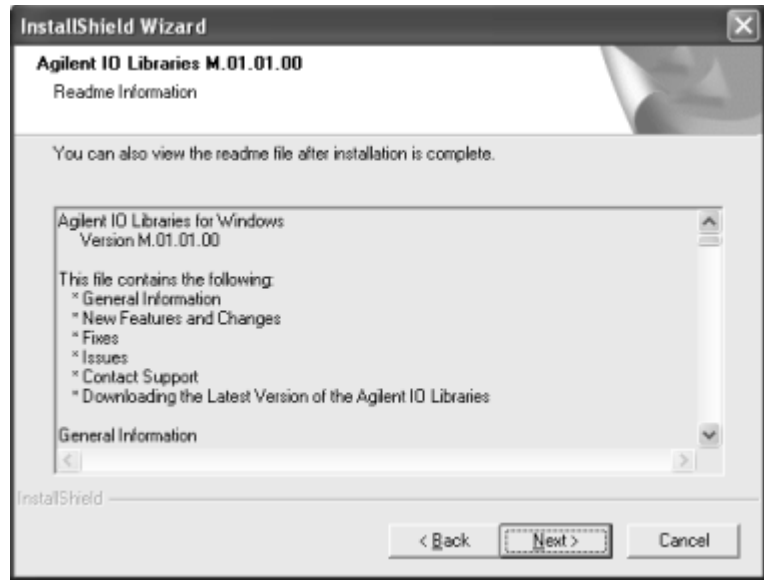

- 7 Scroll through the **Readme Information** screen to display the latest Agilent IO Libraries information.
  - a Agilent highly recommends that you read the **Readme Information** screen for the latest installation information before proceeding further with the installation.
  - b If you do not want to read the **Readme Information** screen at this time, you can return to it after the Agilent IO Libraries are installed by clicking the blue **IO** icon on the Windows taskbar and clicking **View Documentation | IO Libraries Readme**.
- 8 When finished with the **Readme Information** screen, click **Next>** to display the **Select the Installation Option** screen. Click the **Full Installation** box and then click **Next>**.

## 2 Installing the Agilent IO Libraries

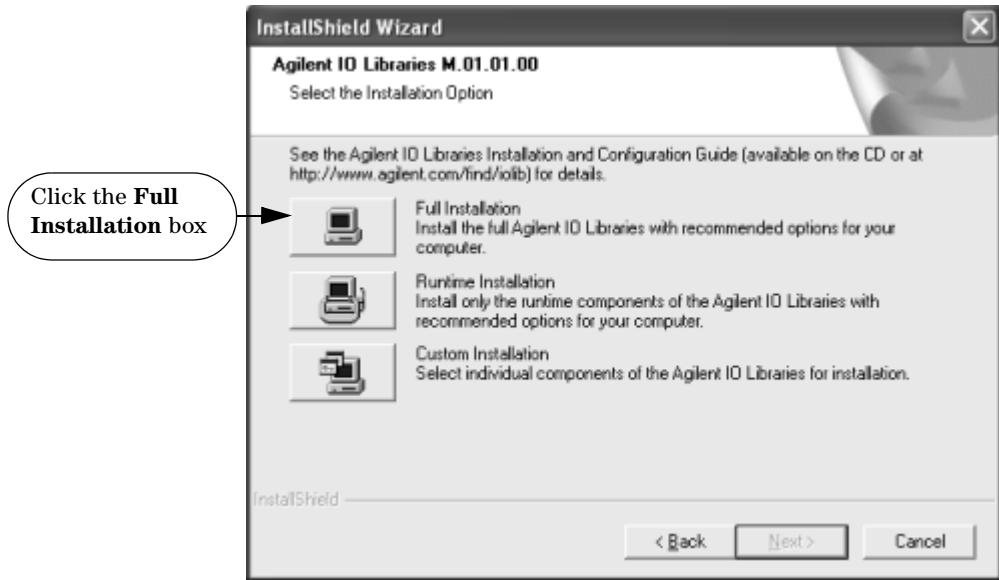

- a If another vendor's VISA is currently installed, a side-by-side **Information** dialog box appears. If this dialog box appears, click **OK** to display the **Question** dialog box (for Windows NT 4.0 ONLY) (Step 8b) or to display the **Current Settings** dialog box (Step 9).



- b** For Windows NT 4.0 ONLY, the **Question** dialog box appears. Click **Yes** to install the drivers, **No** to not install the drivers. For other operating systems, the E8491 drivers are automatically installed, so this box does not appear. continue to Step 9.

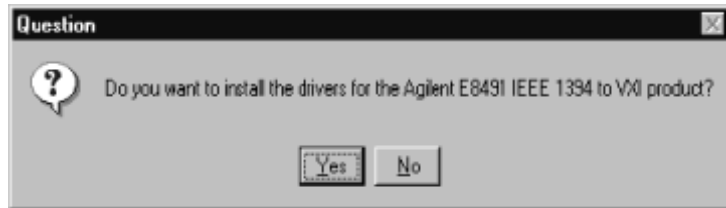

- 9** The **Current Settings** dialog box appears. This box shows the (default) paths where SICL and VISA will be installed and the components that will be installed.

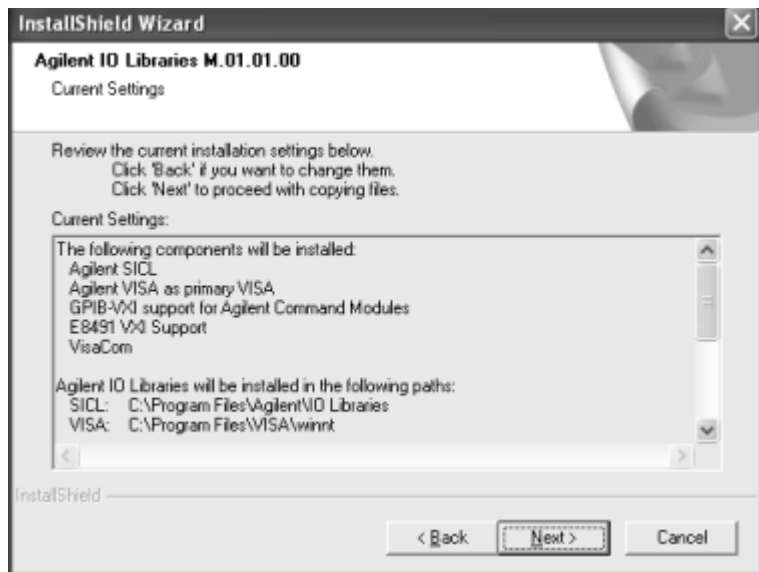

### NOTE

If the side-by-side Information dialog box appears AND you want to set Agilent VISA as primary VISA, or if you want to change the settings listed, follow the instructions in “To Change the Settings.” Otherwise, follow the instructions in “To Accept the Settings.”

---

- a To Accept the Settings.** To accept the settings shown, click **Next>**. Setup then installs the files and displays the **Agilent IO Libraries have been successfully installed** screen (see Step 10).
- b To Change the Settings.** To change the settings shown, click **<Back** to re-display the **Select the Installation Option** screen (see Step 8). From this screen, click the **Custom Installation** box and then click **Next>** to proceed with a custom installation. See “Installing a Custom Version of New Libraries” for more information.

### Installing IO Interfaces

**10** As the last step in the Agilent IO Libraries installation, the **Agilent IO Libraries have been successfully installed** screen appears. Use the guidelines in the following table for the steps to installing IO interfaces.

### NOTE

Before you click **Finish** to install the Agilent IO Libraries, complete Step 11, 12, 13, or 14 (as applicable) and Step 15 to install IO interfaces.

---

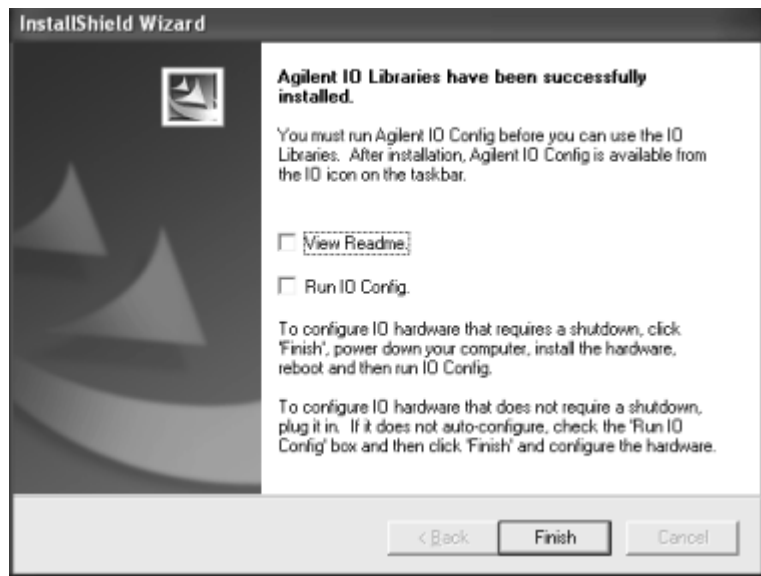

**Table 4** IO Hardware and Operating System Combinations

Windows	Hardware	Use Step
98SE/Me/2000/XP/NT	Any IO hardware (except that listed in Steps 13 and 14) that requires a shutdown for installation	11
98SE/Me/2000/XP/NT	Any IO hardware (except that listed in Steps 13 and 14) that does not require a shutdown for installation	12
98SE/Me/2000/XP	Agilent 1394 FireWire and E8491B VXI Interface cards	13*
98SE/Me/2000/XP	Agilent 82350 PCI GPIB card	14*

\* Do NOT use Steps 13 or 14 for Windows NT.

**11 If an IO Interface Installation Requires Shutdown.** To install and configure IO interfaces that require a power shutdown:

- a If desired, check the **View Readme** box on the **Agilent IO Libraries have been successfully installed** screen.
- b Click **Finish** to complete the Agilent IO Libraries installation. If you checked the **View Readme** box, the *Agilent IO Libraries Readme* file is displayed.
- c Remove the *Agilent IO Libraries for Instrument Control* CD from the CD-ROM drive.
- d Power down your PC, install the IO hardware, and reboot your PC.
- e Go to Step 15.

**12 If an IO Interface Installation Does Not Require Shutdown.** To install and configure IO interfaces that do not require a power shutdown:

- a Check the **View Readme** box (if desired), and check the **Run IO Config** box on the **Agilent IO Libraries have been successfully installed** screen.
- b Connect the hardware to your PC and wait for an auto-configure action.
- c If the hardware does not auto-configure, click **Finish** to display the IO Config main screen. If you checked the **View Readme** box, the *Agilent IO Libraries Readme* file is also displayed.
- d Remove the *Agilent IO Libraries for Instrument Control* CD from the CD-ROM drive.
- e Go to Step 15.

**13 For E8491B VXI Hardware Only.** To install and configure an Agilent 1394 FireWire Card connected to an E8491B VXI Interface card in a Windows 98SE/Me/2000/XP operating system:

- a If desired, check the **View Readme** box on the **Agilent IO Libraries have been successfully installed** screen. Then, click **Finish** to complete the Agilent IO Libraries installation. If

you checked the **View Readme** box, the *Agilent IO Libraries Readme* file is displayed.

- b** Remove the *Agilent IO Libraries for Instrument Control* CD from the CD-ROM drive.
- c** Shut down your PC and turn VXI mainframe power OFF.
- d** Install an IEEE-1394 FireWire card. Use a FireWire cable to connect the IEEE-1394 card to an E8491B VXI interface card in a VXI mainframe. Then, power up the mainframe and turn your PC ON.
- e** As Windows 98SE, Me, 2000, or XP restarts, a **Found New Hardware Wizard** starts. Use the following table for the actions to take for each operating system. Then, go to Step 15.

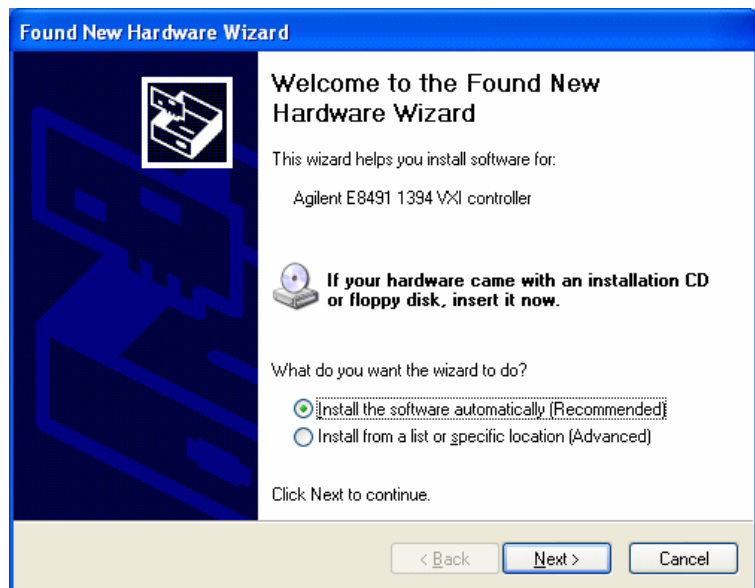

**Table 5** Installing the 1394 Card on Different Operating Systems

OS	Action
98SE	If the Wizard asks for the <i>1394bus.sys</i> file, provide the CD for the Windows 98SE operating system and let the Wizard search for and install the file. When the Wizard asks for the IO Libraries CD, provide the CD or continue to where the Wizard asks for the <i>1394ipt.sys</i> file. Browse to C:\Winnt\system32\drivers\ and click <b>OK</b> .
Me	When the Wizard asks for the IO Libraries CD, provide the CD or continue to where the Wizard asks for the <i>1394ipt.sys</i> file. Browse to C:\Winnt\system32\drivers\ and click <b>OK</b> .
2000/XP	Click <b>Next&gt;</b> to accept the default suggestions. Click <b>Finish</b> to complete the installation.

**14 For 82350 PCI GPIB Hardware Only.** To configure a Windows 98SE/Me/2000/XP operating system that has an Agilent 82350 PCI GPIB Card installed in the PC:

- a** If desired, check the **View Readme** box on the **Agilent IO Libraries have been successfully installed** screen. Then, click **Finish** to complete the Agilent IO Libraries installation. If you checked the **View Readme** box, the *Agilent IO Libraries Readme* file is displayed.
- b** Remove the *Agilent IO Libraries for Instrument Control* CD from the CD-ROM drive.
- c** Shut down the PC and install the 82350 in a PCI slot. Then, power up the mainframe and turn the PC ON. As



Windows 98SE/Me/2000/XP restarts, a **Found New Hardware Wizard** starts.



- d Use the following table for the actions to take for each operating system. Then, go to Step 15.

**Table 6** Installing the 82350 on Different Operating Systems

OS	Action
98SE/Me	When the Wizard asks for the <i>Agilent IO Libraries</i> CD, click <b>OK</b> . When the Wizard asks for the <i>hpioclas.dll</i> file, browse to C : \ windows \ system \ and click <b>OK</b> .
2000/XP	Click <b>Next&gt;</b> to accept the default suggestions. Click <b>Finish</b> to complete the installation.

- 15** At this point, the IO Libraries and necessary IO hardware have been installed. You may still need to configure the installed interfaces.

### Configuring IO Interfaces

To configure the IO interfaces, run IO Config by clicking the blue **IO** icon and clicking **Run IO Config**. Follow the on-screen instructions to configure the interface. See [Chapter 4](#), “Using IO Configuration Utilities” for information on using IO Config.

### Programming via IO Interfaces

You can use VISA Assistant to communicate between your PC and instruments. See [Chapter 4](#), “Using IO Configuration Utilities” for information on VISA Assistant.

To begin programming via the interface using Agilent VISA or SICL, see [Chapter 5](#), “Configuring IO Interfaces.”

For information on using Agilent VISA, see the *Agilent VISA User’s Guide for Windows*. For information on SICL, see the *Agilent SICL User’s Guide for Windows*. Both documents are available in electronic form by clicking the blue **IO** icon on the Windows taskbar and clicking **View Documentation**.

## Installing a Runtime Version of New Libraries

This section shows how to install the **Runtime Installation** option (selected from the Full Installation Package) of new Agilent IO Libraries including:

- Installing the IO Libraries
- Installing IO Interfaces
- Configuring IO Interfaces
- Programming via IO Interfaces

### NOTE

Installing the runtime version of the Agilent IO Libraries allows you to run previously developed applications that use VISA and SICL on all supported IO interfaces. However, you cannot develop new applications using VISA and SICL when the runtime version is installed.

The advantage of using the runtime version is that it requires less hard drive space. For example, installing the full version requires about twice as much space as installing the runtime version. However, with the runtime version, no user manuals, sample programs, or library files are installed.

---

## 2 Installing the Agilent IO Libraries

### Installing the IO Libraries

This section provides suggested steps for performing a Runtime installation of new Agilent IO Libraries, when Agilent IO Libraries have **not** been installed on your PC.

- 1 Turn the PC ON and, as required, install application software such as C/C++, VEE, etc. on your PC.
- 2 Insert the *Agilent IO Libraries for Instrument Control* CD into the CD-ROM drive and wait a few seconds for the application to run.

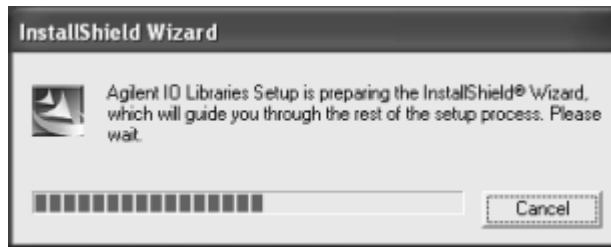

- 3 The installer should automatically start when the CD is inserted. If not, select **Start | Run** and type `<drive>:setup.exe`, where "drive" is your CD-ROM drive.
- 4 The InstallShield® Wizard appears to begin the Agilent IO Libraries installation.

5 After a few seconds, the Title Screen appears.



6 From the Title Screen, click **Next>** to go to the **License Agreement** screen. After reviewing the licensing agreement, click **Yes** to accept the license terms and to display the **Readme Information** screen.

## 2 Installing the Agilent IO Libraries

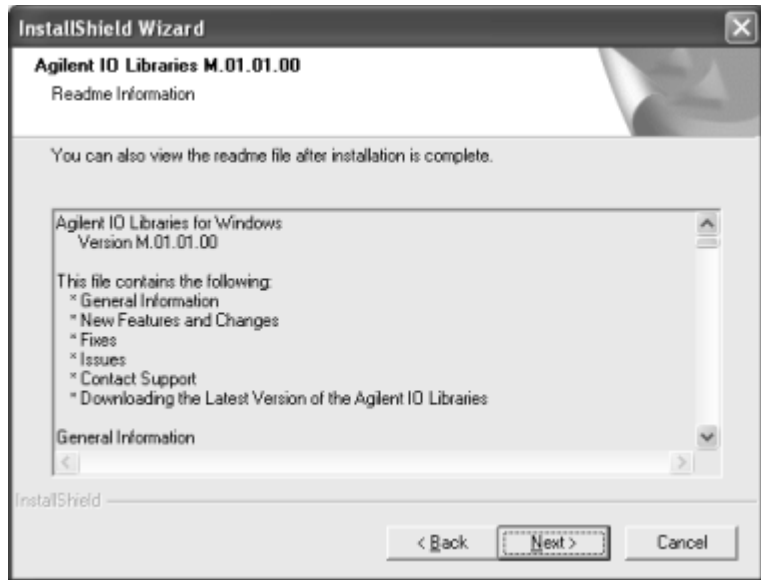

- 7 Scroll through the **Readme Information** screen to display the latest Agilent IO Libraries information.
  - a Agilent highly recommends that you read the **Readme Information** screen for the latest installation information before proceeding further with the installation.
  - b If you do not want to read the **Readme Information** screen at this time, you can return to it after the Agilent IO Libraries are installed by clicking the blue **IO** icon on the Windows taskbar and clicking **View Documentation | IO Libraries Readme**.
- 8 When finished with the **Readme Information** screen, click **Next>** to display the **Select the Installation Option** screen. Click the **Runtime Installation** box and then click **Next>**.

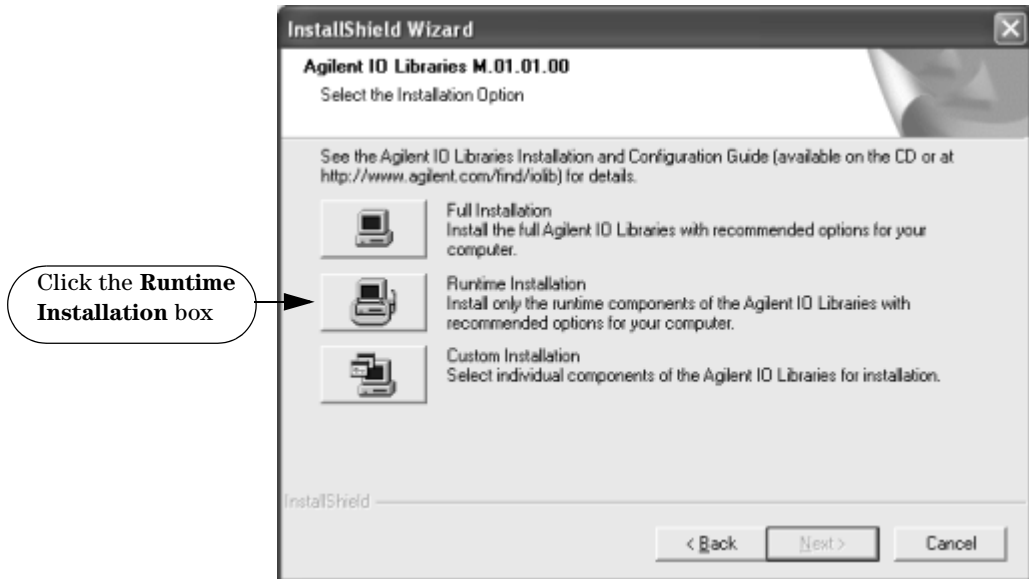
**NOTE**

If you are installing a Runtime version of IO Libraries from the Runtime Installation Package (instead of from a Full Installation Package), the **Full Installation** option will not appear on the **Select the Installation Option** screen. The wizard will display only the **Runtime Installation** and **Custom Installation** options, as shown in the following figure.

## 2 Installing the Agilent IO Libraries



- a If another vendor's VISA is currently installed, a side-by-side **Information** dialog box appears. If this dialog box appears, click **OK** to display the **Question** dialog box (for



Windows NT 4.0 ONLY) (Step 8b) or to display the **Current Settings** dialog box (Step 9).



- b** For Windows NT 4.0 ONLY, the **Question** dialog box appears. Click **Yes** to install the drivers, **No** to not install the drivers. For other operating systems, the E8491 drivers are automatically installed, so this box does not appear. Continue to Step 9.

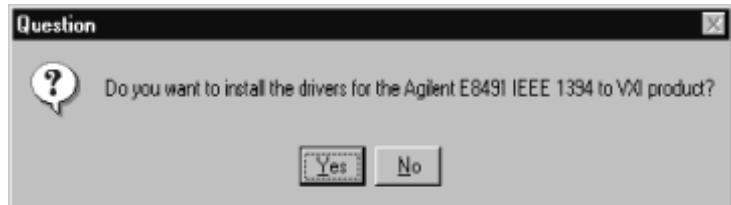

- 9** The **Current Settings** dialog box appears. This box shows the (default) paths where SICL and VISA will be installed and the components that will be installed.

## 2 Installing the Agilent IO Libraries

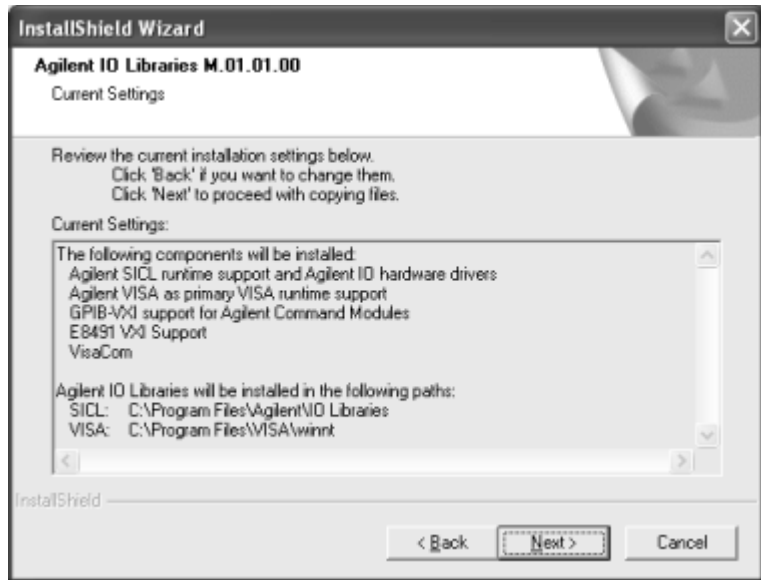

### NOTE

If the side-by-side Information dialog box appears AND you want to set Agilent VISA as primary VISA, or if you want to change the settings listed, follow the instructions in “To Change the Settings.” Otherwise, follow the instructions in “To Accept the Settings.”

- a To Accept the Settings.** To accept the settings shown, click **Next>**. Setup then installs the files and displays the **Agilent IO Libraries have been successfully installed** screen (see Step 10).
- b To Change the Settings.** To change the settings shown, click **<Back** to re-display the **Select the Installation Option** screen (see Step 8). From this screen, click the **Custom Installation** box and then click **Next>** to proceed with a custom installation. See “Installing a Custom Version of New Libraries” for more information.

## Installing IO Interfaces

**10** As the last step in the Agilent IO Libraries installation, the **Agilent IO Libraries have been successfully installed** screen appears. Use the guidelines in Table 7 as you install IO interfaces.

### NOTE

Before you click **Finish** to install the Agilent IO Libraries, complete Step 11, 12, 13, or 14 (as applicable) and Step 15 to install IO interfaces.



**Table 7** Tips for Installing IO Interfaces

Windows	Hardware	Use Step
98SE/Me/2000/XP/NT	Any IO hardware (except that listed in Steps 13 and 14) that requires a shutdown for installation	11

**Table 7** Tips for Installing IO Interfaces

Windows	Hardware	Use Step
98SE/Me/2000/XP/NT	Any IO hardware (except that listed in Steps 13 and 14) that does not require a shutdown for installation	12
98SE/Me/2000/XP	Agilent 1394 FireWire and E8491B VXI Interface cards	13*
98SE/Me/2000/XP	Agilent 82350 PCI GPIB card	14*

\* Do NOT use Steps 13 or 14 for Windows NT.

**11 If an IO Interface Installation Requires Shutdown.** To install and configure IO interfaces that require a power shutdown:

- a** As desired, check the **View Readme** box on the **Agilent IO Libraries have been successfully installed** screen.
- b** Click **Finish** to complete the Agilent IO Libraries installation. If you checked the **View Readme** box, the *Agilent IO Libraries Readme* file is displayed.
- c** Remove the *Agilent IO Libraries for Instrument Control* CD from the CD-ROM drive.
- d** Power down your PC, install the IO hardware, and reboot your PC.
- e** Go to Step 15.

**12 If an IO Interface Installation Does Not Require Shutdown.** To install and configure IO interfaces that do not require a power shutdown:

- a** Check the **View Readme** box (if desired) and check the **Run IO Config** box on the **Agilent IO Libraries have been successfully installed** screen.
- b** Connect the hardware to your PC and wait for an auto-configure action.
- c** If the hardware does not auto-configure, click **Finish** to display the IO Config main screen. If you checked the **View**

**Readme** box, the *Agilent IO Libraries Readme* file is also displayed.

- d** Remove the *Agilent IO Libraries for Instrument Control* CD from the CD-ROM drive.
- e** Go to Step 15.

**13 For E8491B VXI Hardware Only.** To install and configure an Agilent 1394 FireWire Card connected to an E8491B VXI Interface card in a Windows 98SE/Me/2000/XP operating system:

- a** If desired, check the **View Readme** box on the **Agilent IO Libraries have been successfully installed** screen. Then, click **Finish** to complete the Agilent IO Libraries installation. If you checked the **View Readme** box, the *Agilent IO Libraries Readme* file is displayed.
- b** Remove the *Agilent IO Libraries for Instrument Control* CD from the CD-ROM drive.
- c** Shut down your PC and turn VXI mainframe power OFF.
- d** Install an IEEE-1394 FireWire card. Use a FireWire cable to connect the IEEE-1394 card to an E8491B VXI interface card in a VXI mainframe. Then, power up the mainframe and turn your PC ON.
- e** As Windows 98SE, Me, 2000, or XP restarts, a **Found New Hardware Wizard** starts. Use the following table for the actions to take for each operating system. Then, go to Step 15.

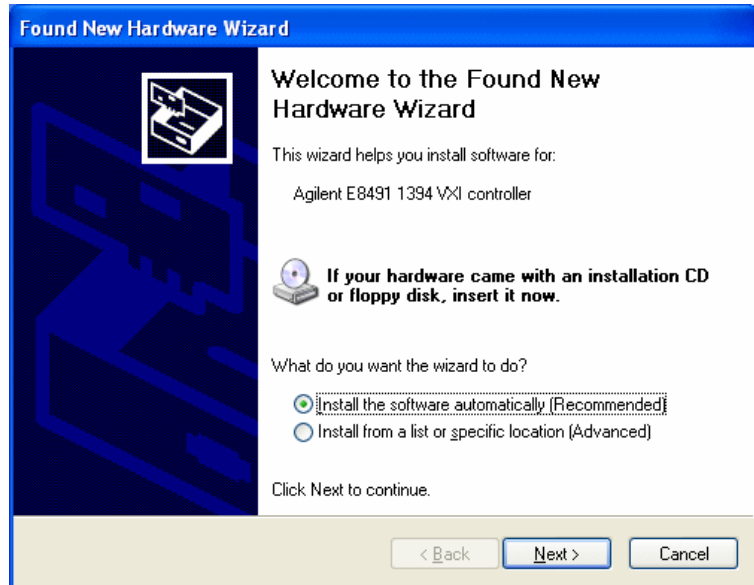

**Table 8** Installing the 1394 for Each Operating System

OS	Action
98SE	If the Wizard asks for the <i>1394bus.sys</i> file, provide the CD for the Windows 98SE operating system and let the Wizard search for and install the file. When the Wizard asks for the IO Libraries CD, provide the CD or continue to where the Wizard asks for the <i>1394ipt.sys</i> file. Browse to C:\Winnt\system32\drivers\ and click <b>OK</b> .
Me	When the Wizard asks for the IO Libraries CD, provide the CD or continue to where the Wizard asks for the <i>1394ipt.sys</i> file. Browse to C:\Winnt\system32\drivers\ and click <b>OK</b> .
2000/XP	Click <b>Next&gt;</b> to accept the default suggestions. Click <b>Finish</b> to complete the installation.

- 14 For 82350 PCI GPIB Hardware Only.** To configure a Windows 98SE/Me/2000/XP operating system that has an Agilent 82350 PCI GPIB Card installed in the PC:
- a If desired, check the **View Readme** box on the **Agilent IO Libraries have been successfully installed** screen. Then, click **Finish** to complete the Agilent IO Libraries installation. If you checked the **View Readme** box, the *Agilent IO Libraries Readme* file is displayed. Remove the *Agilent IO Libraries for Instrument Control* CD from the CD-ROM drive.
  - b Shut down the PC and install the 82350 in a PCI slot. Then, power up the mainframe and turn the PC ON. As Windows 98SE/Me/2000/XP restarts, a **Found New Hardware Wizard** starts.



- c Use the following table for the actions to take for each operating system. Then, go to Step 15.

**Table 9** Installing the 82350 on Different Operating Systems

OS	Action
98SE/Me	When the Wizard asks for the IO Libraries CD, click <b>OK</b> . When the Wizard asks for the <i>hpioclas.dll</i> file, browse to C:\windows\system\ and click <b>OK</b> .
2000/XP	Click <b>Next&gt;</b> to accept the default suggestions. Click <b>Finish</b> to complete the installation.

**15** At this point, the IO Libraries and necessary IO hardware have been installed. You may still need to configure the installed interfaces.

### Configuring IO Interfaces

To configure the IO interfaces, run IO Config by clicking the blue **IO** icon and clicking **Run IO Config**. Follow the on-screen instructions to configure the interface. See [Chapter 4](#), “Using IO Configuration Utilities” for information on using IO Config.

### Programming via IO Interfaces

You can use VISA Assistant to communicate between your PC and instruments. See [Chapter 4](#), “Using IO Configuration Utilities” for information on VISA Assistant.

To begin programming via the interface using Agilent VISA or SICL, see [Chapter 5](#), “Configuring IO Interfaces.”

For information on using Agilent VISA, see the *Agilent VISA User’s Guide for Windows*. For information on SICL, see the *Agilent SICL User’s Guide for Windows*. Both documents are available in electronic form by clicking the blue **IO** icon on the Windows taskbar and clicking **View Documentation**.



## Installing a Custom Version of New Libraries

This section shows how to install a custom version of new Agilent IO Libraries, including:

- Installing the IO Libraries
- Installing IO Interfaces
- Configuring IO Interfaces
- Programming via IO Interfaces

### Installing the IO Libraries

This section provides steps for a custom installation of new Agilent IO Libraries, when Agilent IO Libraries are **not** installed on your PC. You can use the Custom Installation option to select the components of the Agilent IO Libraries you want to install.

- 1 Turn the PC ON and, as required, install application software such as C/C++, VEE, etc. on your PC.
- 2 Insert the *Agilent IO Libraries for Instrument Control* CD into the CD-ROM drive and wait a few seconds for the application to run.
- 3 The installer should automatically start when the CD is inserted. If not, select **Start | Run** and type `<drive>:setup.exe`, where “drive” is your CD-ROM drive.
- 4 The InstallShield® Wizard appears to begin IO Libraries installation.

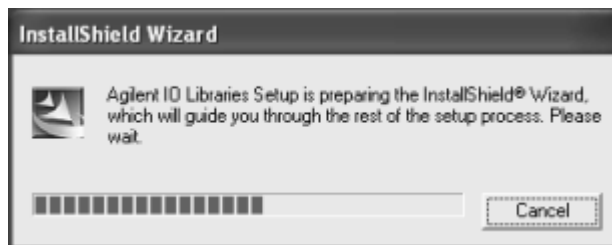

- 5 After a few seconds, the Title Screen appears.

## 2 Installing the Agilent IO Libraries

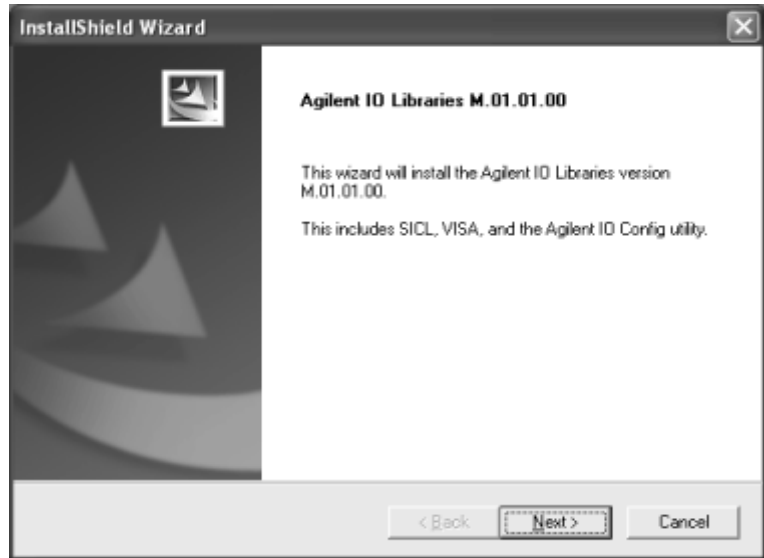

- 6 From the Title Screen, click **Next>** to go to the **License Agreement** screen. Click **Yes** to accept the license terms and to display the **Readme Information** screen.

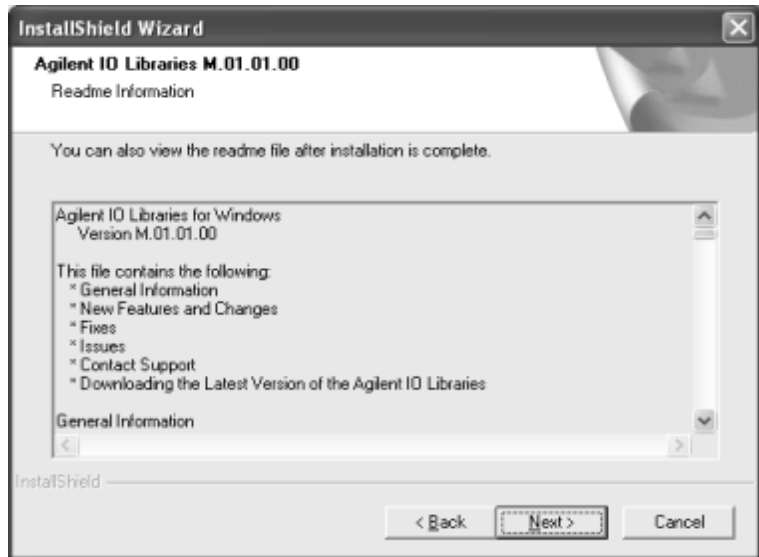

- 7 Scroll through the **Readme Information** screen to display the latest Agilent IO Libraries information.
  - a Agilent highly recommends that you read the **Readme Information** screen for the latest installation information before proceeding further with the installation.
  - b If you do not want to read the **Readme Information** screen at this time, you can return to it after the Agilent IO Libraries are installed by clicking the blue **IO** icon on the Windows taskbar and clicking **View Documentation | IO Libraries Readme**.
- 8 When finished with the **Readme Information** screen, click **Next>** to display the **Select the Installation Option** screen.

## 2 Installing the Agilent IO Libraries

- 9 From the **Select the Installation Option** screen, click the **Custom Installation** box and then click **Next>** to display the **SICL Installation Directory** screen.

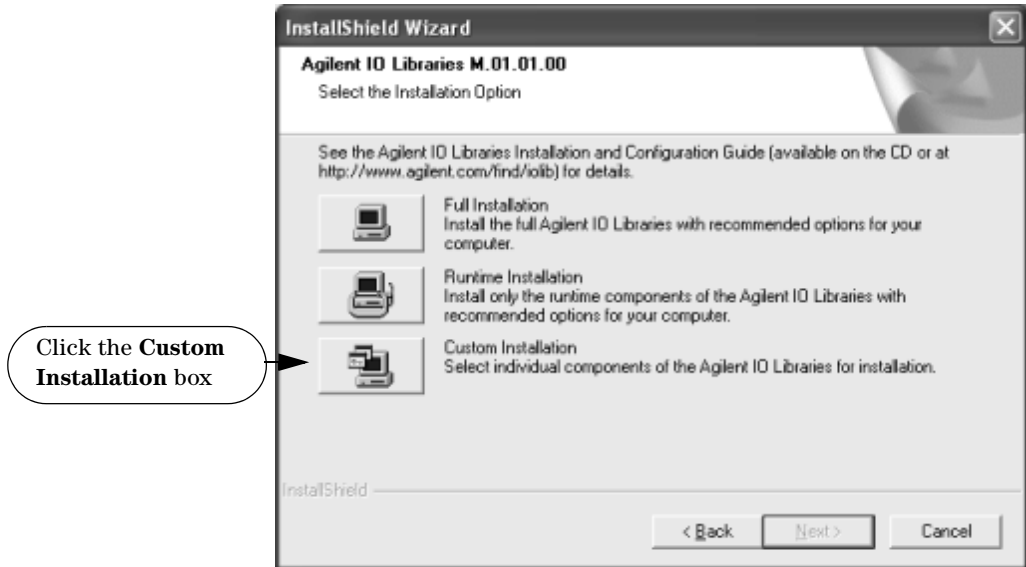

- 10 By default, SICL is installed in `C:\Program Files\Agilent\IO Libraries`. Click **Next>** to accept the default setting, or set the directory you want and then click **Next>** to display the **VISA installation directory** screen.
- 11 By default, VISA is installed in `C:\Program Files\VISA`. Click **Next>** to accept the default setting, or set the directory you want and then click **Next>** to display the **Select Type of Installation** screen.

### NOTE

If another vendor's VISA is detected, you are not prompted for the VISA directory. The existing VISA directory is used.

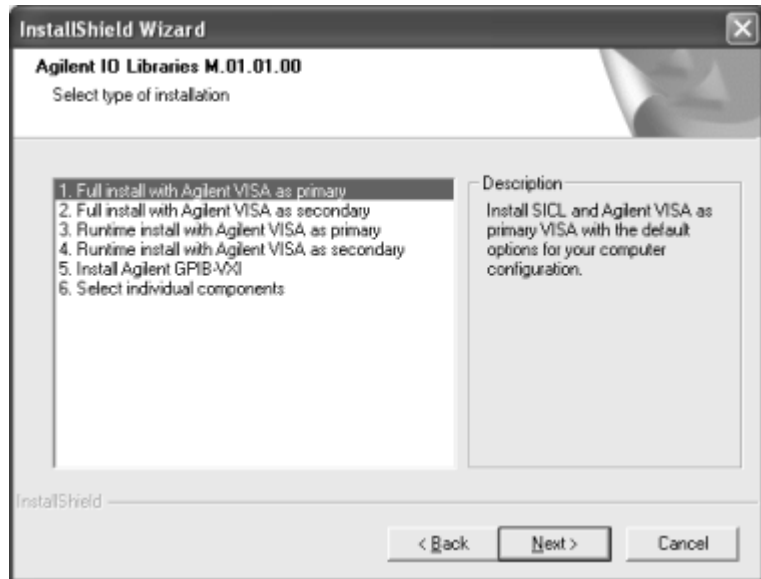

**12** Use the following table for guidelines to selecting the correct type of installation for your application. Highlight your selection and then click **Next>** to install the option selected. Then, see the applicable step for the selection you made.

**Table 10** Guidelines for Selecting Installation Type

Option	See Step
<b>1. Full install with Agilent VISA as primary</b>	
Installs SICL and Agilent VISA as primary VISA with the default options for your computer configuration. This is the default choice if another vendor's VISA is not detected. If another vendor's VISA is installed, installing this option <b>overwrites</b> the other vendor's VISA. This option allows development and runtime capabilities using SICL and Agilent VISA for all supported interfaces.	13

**Table 10** Guidelines for Selecting Installation Type

Option	See Step
<b>2. Full install with Agilent VISA as secondary</b>	
<p>Installs SICL and Agilent VISA as secondary VISA (side-by-side) with the default options for your computer configuration. This is the default choice if another vendor's VISA is detected. If another vendor's VISA is installed, installing this option <b>does not overwrite</b> another vendor's VISA.</p> <p>Normally, VISA programs use the primary VISA (either Agilent VISA or another vendor's VISA). VISA programs can be written to access Agilent VISA whether it is the primary or the secondary VISA. If you are using only SICL applications, you may want to install Agilent VISA as secondary VISA so that another vendor's VISA can be installed without conflict.</p>	14
<b>3. Runtime install with Agilent VISA as primary</b>	
<p>Installs SICL and runtime Agilent VISA as primary VISA with the default options for your computer configuration. If another vendor's VISA is installed, installing this option <b>overwrites</b> the other vendor's VISA. This option allows runtime only capabilities (not program development) using SICL and Agilent VISA for all supported interfaces.</p>	15
<b>4. Runtime install with Agilent VISA as secondary</b>	
<p>Installs SICL and runtime Agilent VISA as secondary VISA with the default options for your computer configuration. If another vendor's VISA is installed, installing this option <b>does not overwrite</b> the other vendor's VISA. This option allows runtime only capabilities (not program development) using SICL and Agilent VISA for all supported interfaces.</p>	16
<b>5. Install Agilent GPIB-VXI</b>	
<p>Use this option if your system includes an Agilent VXI Command Module (such as an E1406, etc.) and another vendor's VISA. This option provides GPIB-VXI support for VXI Command Modules on another vendor's VISA. SICL and Agilent VISA are <b>not</b> installed.</p>	17

**Table 10** Guidelines for Selecting Installation Type

Option	See Step
<b>6. Select Individual Components</b>	
Allows you to install individually selected components of the IO Libraries, including SICL, VISA, E8491, and GPIB-VXI Support components.	18

**13 Option 1. Full install with Agilent VISA as primary**

- a From the **Select Type of Installation** screen, select **1. Full install with Agilent VISA as primary** and then click **Next>** to display the **Question** screen for E8491 support (for Windows NT 4.0 only).

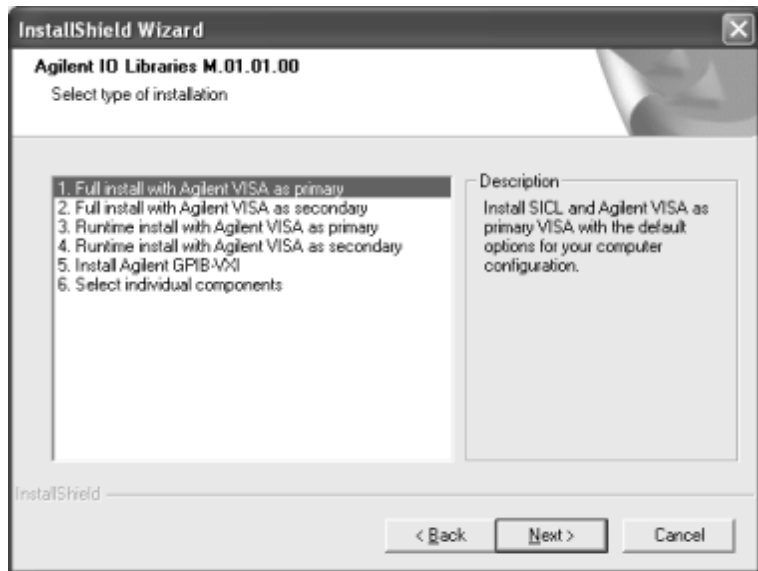

- b For Windows NT 4.0 ONLY, the **Question** dialog box appears. Click **Yes** to install the drivers, **No** to not install the drivers.
- c For other operating systems, the E8491 drivers are automatically installed, so this box does not appear. Continue to step **13d**.

## 2 Installing the Agilent IO Libraries



- d The **Current Settings** dialog box appears. This box shows the (default) paths where SICL and VISA will be installed and the components that will be installed.

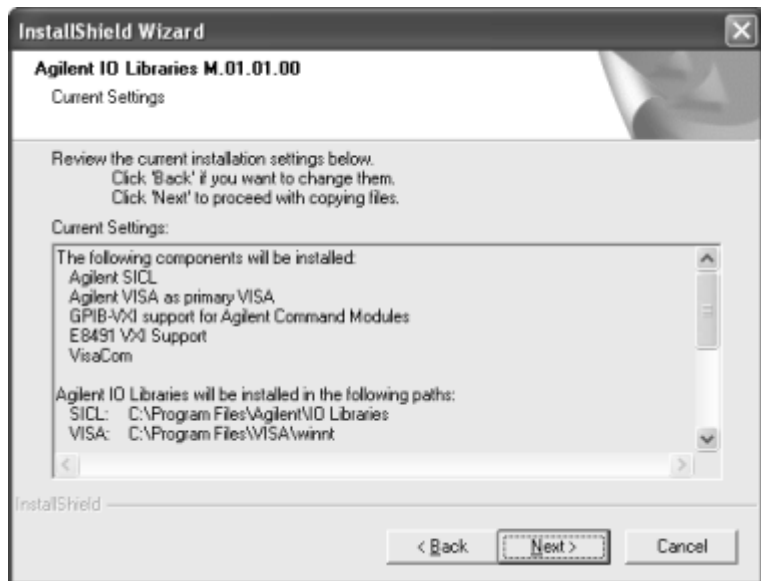

- e **To Accept the Settings.** To accept the settings shown, click **Next>**. Setup then installs the files and displays the **Agilent IO Libraries have been successfully installed** screen (see Step 19).
- f **To Change the VISA Installation Path.** To change the VISA installation path, click **<Back** on the **Current Settings**



screen and **<Back** on the **Select Type of Installation** screen to display the **VISA Installation Directory** screen. Change the path as desired and then click **Next>**.

**g To Change the SICL Installation Path.** To change the SICL installation path, click **<Back** on the **Current Settings** screen and **<Back** on the **Select Type of Installation** screen to display the **VISA Installation Directory** screen. Then, click **<Back** on the **VISA Installation Directory** screen to display the **SICL Installation Directory** screen. Change the path as desired and then click **Next>**.

**h To Change the IO Libraries Components to be installed.** To change the components to be installed, click **<Back** to re-display the **Select Type of Installation** screen. From this screen, select the **6. Choose Individual Components** box and then click **Next>** to proceed with a custom installation. See Step 18 for installation guidelines.

#### **14 Option 2. Full install with Agilent VISA as secondary**

**a** From the **Select Type of Installation** screen, select **2. Full install with Agilent VISA as secondary** and then click **Next>** to display the **Question** screen for E8491 support (for Windows NT 4.0 only).

## 2 Installing the Agilent IO Libraries

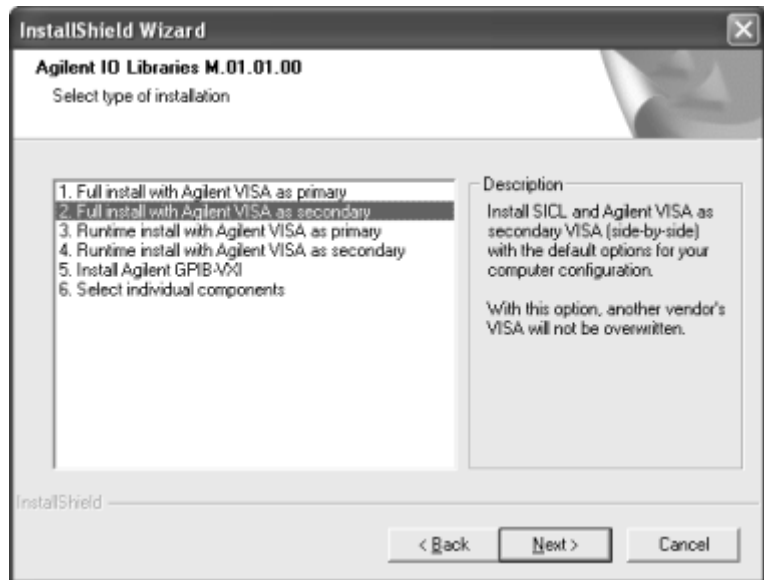

- b For Windows NT 4.0 ONLY, the **Question** dialog box appears. Click **Yes** to install the drivers, **No** to not install the drivers.
- c For other operating systems, the E8491 drivers are automatically installed, so this box does not appear. Continue to Step 14d.



- d The **Current Settings** dialog box appears. This box shows the (default) paths where SICL and VISA will be installed and the components that will be installed.



- e **To Accept the Settings.** To accept the settings shown, click **Next>**. Setup then installs the files and displays the **Agilent IO Libraries have been successfully installed** screen (see Step 19).
- f **To Change the VISA Installation Path.** To change the VISA installation path, click **<Back** on the **Current Settings** screen and **<Back** on the **Select Type of Installation** screen to display the **VISA Installation Directory** screen. Change the path as desired and then click **Next>**.
- g **To Change the SICL Installation Path.** To change the SICL installation path, click **<Back** on the **Current Settings** screen and **<Back** on the **Select Type of Installation** screen to display the **VISA Installation Directory** screen. Then, click **<Back** on the **VISA Installation Directory** screen to display the

**SICL Installation Directory** screen. Change the path as desired and then click **Next>**.

**h To Change the IO Libraries Components to be installed.**

To change the components to be installed, click **<Back** to re-display the **Select Type of Installation** screen. From this screen, select the **6. Choose Individual Components** box and then click **Next>** to proceed with a custom installation. See Step 18 for installation guidelines.

**15 Option 3. Runtime install with Agilent VISA as primary**

- a** From the **Select Type of Installation** screen, select **3. Runtime install with Agilent VISA as primary** and then click **Next>** to display the **Question** screen for E8491 support (for Windows NT 4.0 only).

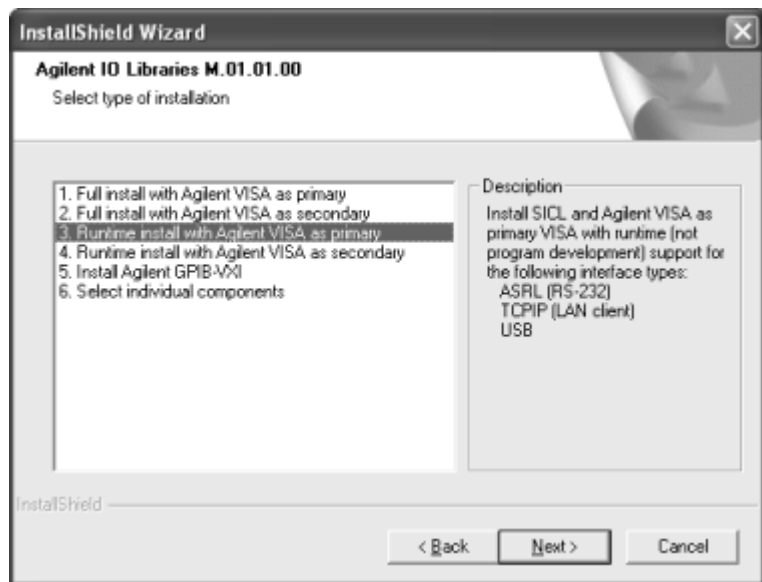

- b For Windows NT 4.0 ONLY, the **Question** dialog box appears. Click **Yes** to install the drivers, **No** to not install the drivers.
- c For other operating systems, the E8491 drivers are automatically installed, so this box does not appear. Continue to Step 15d.



- d The **Current Settings** dialog box appears. This box shows the (default) paths where SICL and VISA will be installed and the components that will be installed.

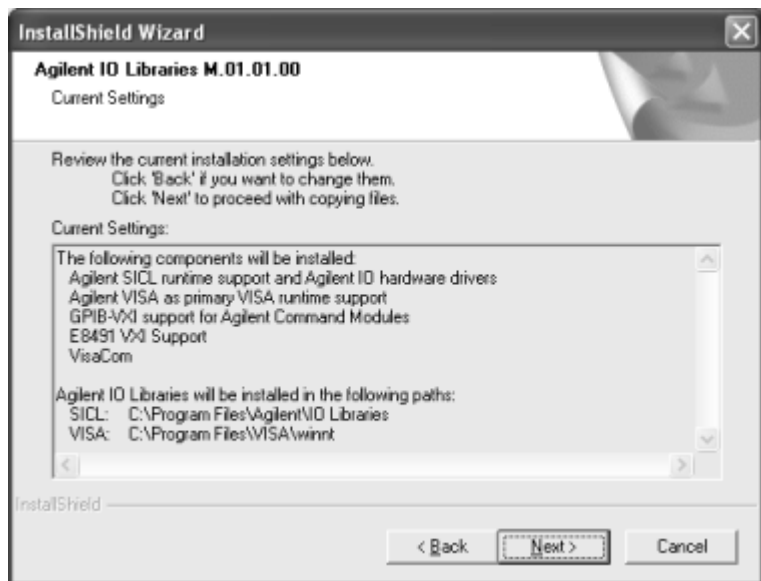

- e **To Accept the Settings.** To accept the settings shown, click **Next>**. Setup then installs the files and displays the **Agilent IO Libraries have been successfully installed** screen (see Step 19).
- f **To Change the VISA Installation Path.** To change the VISA installation path, click **<Back** on the **Current Settings** screen and **<Back** on the **Select Type of Installation** screen to display the **VISA Installation Directory** screen. Change the path as desired and then click **Next>**.
- g **To Change the SICL Installation Path.** To change the SICL installation path, click **<Back** on the **Current Settings** screen and **<Back** on the **Select Type of Installation** screen to display the **VISA Installation Directory** screen. Then, click **<Back** on the **VISA Installation Directory** screen to display the **SICL Installation Directory** screen. Change the path as desired and then click **Next>**.
- h **To Change the IO Libraries Components to be installed.** To change the components to be installed, click **<Back** to re-display the **Select Type of Installation** screen. From this screen, select the **6. Choose Individual Components** box and then click **Next>** to proceed with a custom installation. See Step 18 for installation guidelines.

- 16 Option 4. Runtime install with Agilent VISA as secondary**
- a** From the **Select Type of Installation** screen, select **4. Runtime install with Agilent VISA as secondary**.

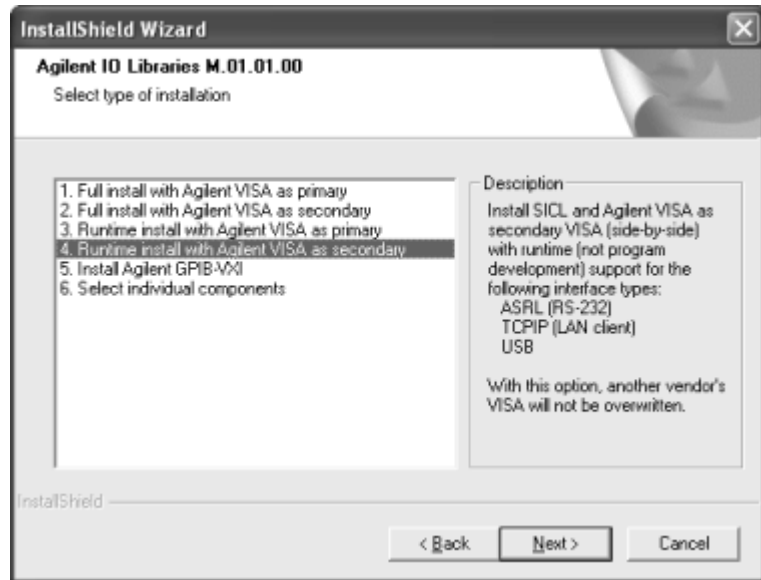

## 2 Installing the Agilent IO Libraries

- b** Then, click **Next** to display the **Current Settings** dialog box. This box shows the (default) paths where SICL will be installed and the components that will be installed.

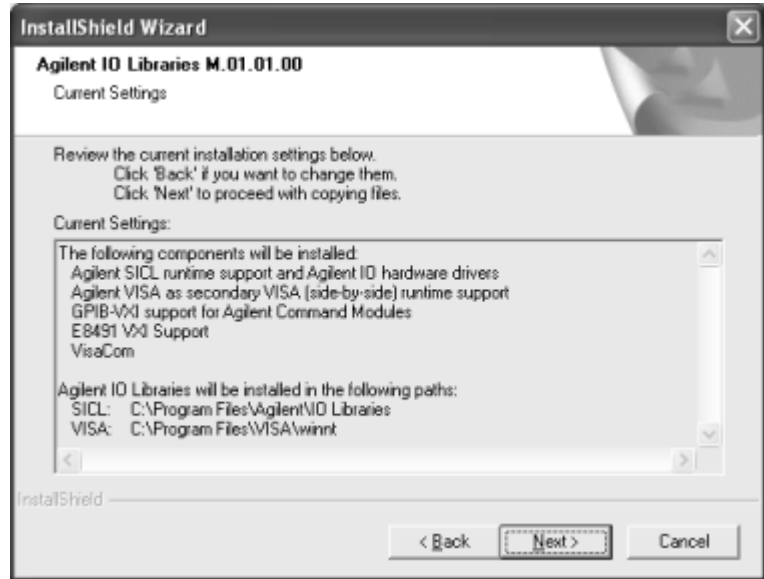

- c To Accept the Settings.** To accept the settings shown, click **Next>**. Setup then installs the files and displays the **Agilent IO Libraries have been successfully installed** screen (see Step 19).
- d To Change the VISA Installation Path.** To change the VISA installation path, click **<Back** on the **Current Settings** screen and **<Back** on the **Select Type of Installation** screen to display the **VISA Installation Directory** screen. Change the path as desired and then click **Next>**.
- e To Change the SICL Installation Path.** To change the SICL installation path, click **<Back** on the **Current Settings** screen and **<Back** on the **Select Type of Installation** screen to display the **VISA Installation Directory** screen. Then, click **<Back** on the **VISA Installation Directory** screen to display the



**SICL Installation Directory** screen. Change the path as desired and then click **Next>**.

**f To Change the IO Libraries Components to be installed.**

To change the components to be installed, click **<Back** to re-display the **Select Type of Installation** screen. From this screen, select the **6. Choose Individual Components** box and then click **Next>** to proceed with a custom installation. See Step 18 for installation guidelines.

**17 Option 5. Install Agilent GPIB-VXI**

**a From the **Select Type of Installation** screen, select **5. Install Agilent GPIB-VXI**.**

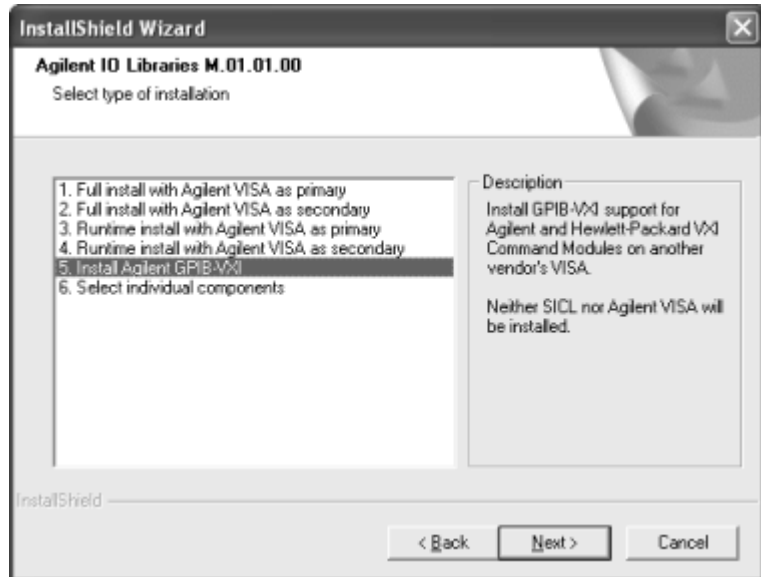

**b Then, click **Next>** to display the **Current Settings** dialog box. This box shows the (default) paths where VISA and SICL will be installed and the components that will be installed.**

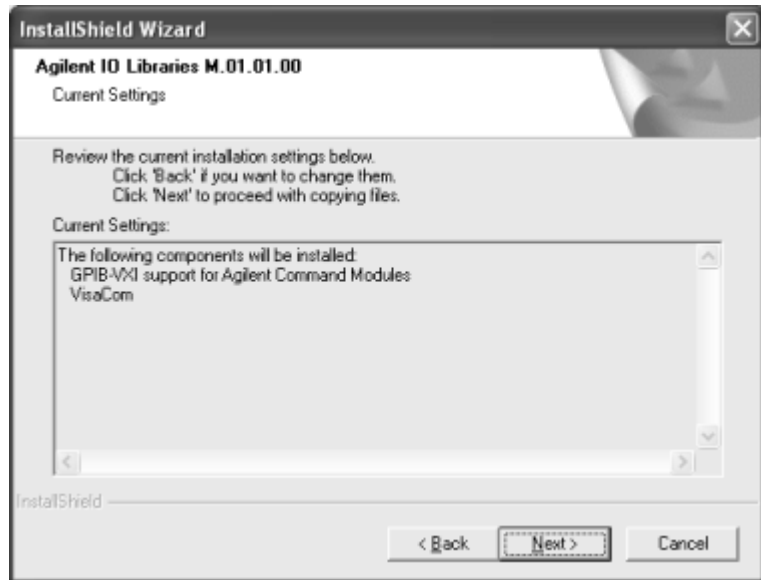

- c To Accept the Settings.** To accept the settings shown, click **Next>**. Setup then installs the files and displays the **Agilent IO Libraries have been successfully installed** screen (see Step 19).
- d To Change the SICL Installation Path.** To change the SICL installation path, click **<Back** on the **Current Settings** screen and **<Back** on the **Select Type of Installation** screen to display the **VISA Installation Directory** screen. Then, click **<Back** on the **VISA Installation Directory** screen to display the **SICL Installation Directory** screen. Change the path as desired and then click **Next>**.

### NOTE

GPIB-VXI can only be installed if another vendor's VISA is already installed. Thus, you are not prompted for the VISA installation path.

- e To Change the IO Libraries Components to be installed.** To change the components to be installed, click **<Back** to

re-display the **Select Type of Installation** screen. From this screen, select the **6. Choose Individual Components** box and then click **Next>** to proceed with a custom installation. See Step 18 for installation guidelines.

### 18 Option 6. Select individual components

- a From the **Select Type of Installation** screen, select **6. Select individual components**.

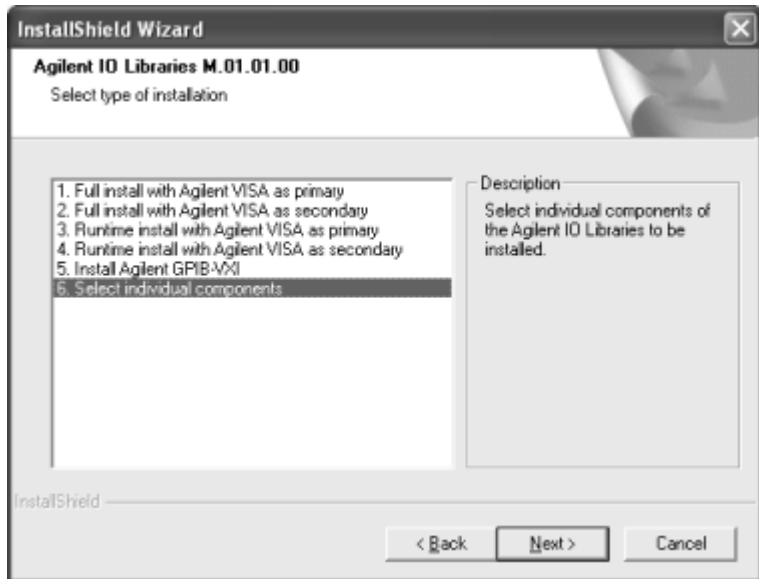

## 2 Installing the Agilent IO Libraries

- b Then, click **Next>** to display the **Select Individual Components** dialog box.

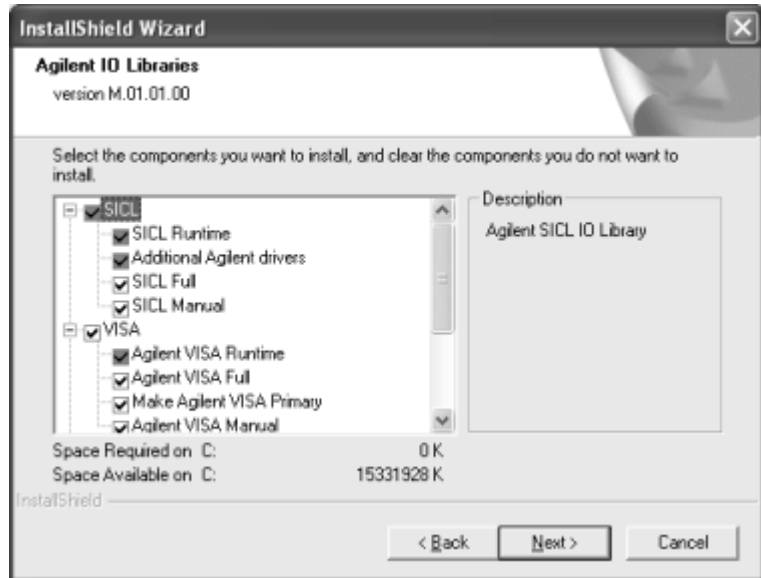

- c Select the components you want to install and clear the components you do not want to install. Then, click **Next>** to display the **Current Settings** dialog box. This box shows the (default) paths where VISA and SICL will be installed and the components that will be installed.

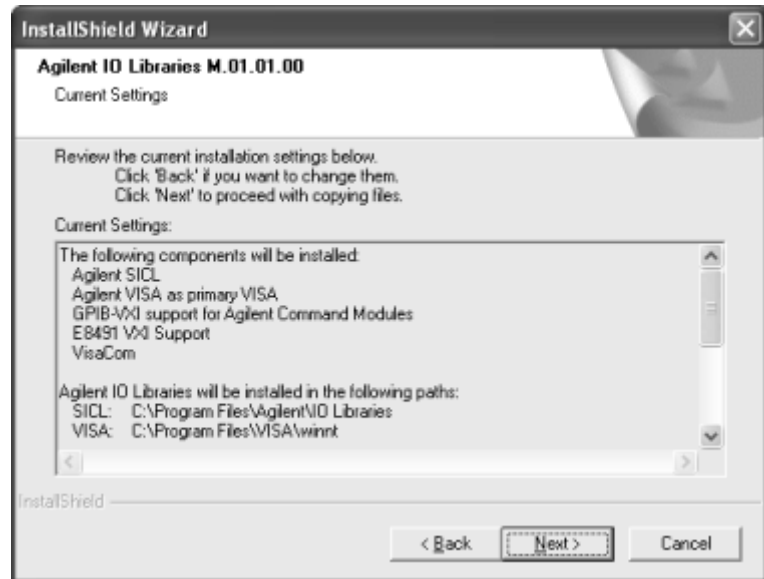

- d To Accept the Settings.** To accept the settings shown, click **Next>**. Setup then installs the files and displays the **Agilent IO Libraries have been successfully installed** screen (see Step 19).
- e To Change the VISA Installation Path.** To change the VISA installation path, click **<Back** on the **Current Settings** screen and **<Back** on the **Select Type of Installation** screen to display the **VISA Installation Directory** screen. Change the path as desired and then click **Next>**.
- f To Change the SICL Installation Path.** To change the SICL installation path, click **<Back** on the **Current Settings** screen and **<Back** on the **Select Type of Installation** screen to display the **VISA Installation Directory** screen. Then, click **<Back** on the **VISA Installation Directory** screen to display the **SICL Installation Directory** screen. Change the path as desired and then click **Next>**.
- g To Change the IO Libraries Components to be installed.** To change the components to be installed, click **<Back** to

re-display the **Select Individual Components** screen. Change the components to be installed and then click **Next>**.

### Installing IO Interfaces

**19** As the last step in the Agilent IO Libraries installation, the **Agilent IO Libraries have been successfully installed** screen appears. Use the guidelines in the following table for the steps to installing IO interfaces.

#### NOTE

Before you click **Finish** to install the Agilent IO Libraries, complete Step 20, 21, 22, or 23 (as applicable) and Step 24 to install IO interfaces.



**Table 11** Final Installation Steps

Windows	Hardware	Use Step
98SE/Me/2000/XP/NT	Any IO hardware (except that listed in Steps 22 and 23) that requires a shutdown for installation	20
98SE/Me/2000/XP/NT	Any IO hardware (except that listed in Steps 22 and 23) that does not require a shutdown for installation	21
98SE/Me/2000/XP	Agilent 1394 FireWire and E8491B VXI Interface cards	22*
98SE/Me/2000/XP	Agilent 82350 PCI GPIB card	23*

\* Do NOT use Steps 22 or 23 for Windows NT.

**20 If an IO Interface Installation Requires Shutdown.** To install and configure IO interfaces that require a power shutdown:

- a** If desired, check the **View Readme** box on the **Agilent IO Libraries have been successfully installed** screen.
- b** Click **Finish** to complete the Agilent IO Libraries installation. If you checked the **View Readme** box, the *Agilent IO Libraries Readme* file is displayed.
- c** Remove the *Agilent IO Libraries for Instrument Control* CD from the CD-ROM drive.
- d** Power down your PC, install the IO hardware, and reboot your PC.
- e** Go to Step 24.

### 21 If an IO Interface Installation Does Not Require Shutdown.

To install and configure IO interfaces that do not require a power shutdown:

- a Check the **View Readme** box (if desired) and check the **Run IO Config** box on the **Agilent IO Libraries have been successfully installed** screen.
- b Connect the hardware to your PC and wait for an auto-configure action.
- c If the hardware does not auto-configure, click **Finish** to display the IO Config main screen. If you checked the **View Readme** box, the *Agilent IO Libraries Readme* file is also displayed.
- d Remove the *Agilent IO Libraries for Instrument Control* CD from the CD-ROM drive.
- e Go to Step 24.

### 22 For E8491B VXI Hardware Only. To install and configure an Agilent 1394 FireWire Card connected to an E8491B VXI Interface card in a Windows 98SE/Me/2000/XP operating system:

- a If desired, check the **View Readme** box on the **Agilent IO Libraries have been successfully installed** screen. Then, click **Finish** to complete the Agilent IO Libraries installation. If you checked the **View Readme** box, the *Agilent IO Libraries Readme* file is displayed.
- b Remove the *Agilent IO Libraries for Instrument Control* CD from the CD-ROM drive.
- c Shut down your PC and turn VXI mainframe power OFF.
- d Install an IEEE-1394 FireWire card. Use a FireWire cable to connect the IEEE-1394 card to an E8491B VXI interface card in a VXI mainframe. Then, power up the mainframe and turn your PC ON.
- e As Windows 98SE, Me, 2000, or XP restarts, a **Found New Hardware Wizard** starts. Use the following table for the



actions to take for each operating system. Then, go to Step 24.

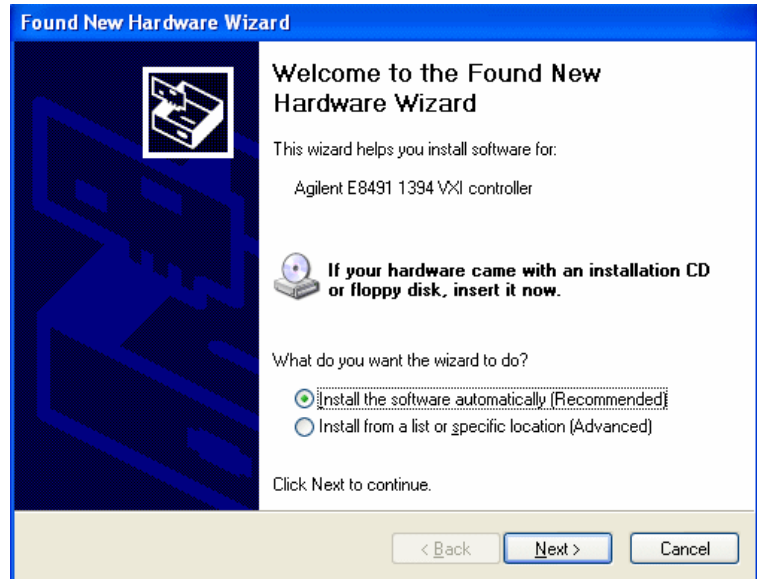

**Table 12** Installing a USB port

OS	Action
98SE	If the Wizard asks for the <i>1394bus.sys</i> file, provide the CD for the Windows 98SE operating system and let the Wizard search for and install the file. When the Wizard asks for the IO Libraries CD, provide the CD or continue to where the Wizard asks for the <i>1394ipt.sys</i> file. Browse to C:\Winnt\system32\drivers\ and click <b>OK</b> .
Me	When the Wizard asks for the IO Libraries CD, provide the CD or continue to where the Wizard asks for the <i>1394ipt.sys</i> file. Browse to C:\Winnt\system32\drivers\ and click <b>OK</b> .
2000/XP	Click <b>Next&gt;</b> to accept the default suggestions. Click <b>Finish</b> to complete the installation.

- 23 For 82350 PCI GPIB Hardware Only.** To configure a Windows 98SE/Me/2000/XP operating system that has an Agilent 82350 PCI GPIB Card installed in the PC:
- If desired, check the **View Readme** box on the **Agilent IO Libraries have been successfully installed** screen. Then, click **Finish** to complete the Agilent IO Libraries installation. If you checked the **View Readme** box, the *Agilent IO Libraries Readme* file is displayed.
  - Remove the *Agilent IO Libraries for Instrument Control* CD from the CD-ROM drive.
  - Shut down the PC and install the 82350 in a PCI slot. Then, power up the mainframe and turn the PC ON. As Windows 98SE/Me/2000/XP restarts, a **Found New Hardware Wizard** starts.



- Use the following table for the actions to take for each operating system. Then, go to Step 24.

**Table 13** Installing the IO Libraries

OS	Action
98SE/Me	When the Wizard asks for the Agilent IO Libraries CD, click <b>OK</b> . When the Wizard asks for the <i>hpioclas.dll</i> file, browse to C:\windows\system\ and click <b>OK</b> .
2000/XP	Click <b>Next&gt;</b> to accept the default suggestions. Click <b>Finish</b> to complete the installation.

**24** At this point, the IO Libraries and necessary IO hardware have been installed. You may still need to configure the installed interfaces.

## Configuring IO Interfaces

To configure the IO interfaces, run IO Config by clicking the blue **IO** icon and clicking **Run IO Config**. Follow the on-screen instructions to configure the interface. See [Chapter 4](#), “Using IO Configuration Utilities” for information on using IO Config.

## Programming via IO Interfaces

You can use VISA Assistant to communicate between your PC and instruments. See [Chapter 4](#), “Using IO Configuration Utilities” for information on VISA Assistant.

To begin programming via the interface using Agilent VISA or SICL, see [Chapter 5](#), “Configuring IO Interfaces.”

For information on using Agilent VISA, see the *Agilent VISA User's Guide for Windows*. For information on SICL, see the *Agilent SICL User's Guide for Windows*. Both documents are available in electronic form by clicking the blue **IO** icon on the Windows taskbar and clicking **View Documentation**.

### Upgrading Existing Libraries

This section provides suggested steps for upgrading a current version of the Agilent IO Libraries to a newer version of the Agilent IO Libraries, including:

- Installing the IO Libraries
- Installing IO Interfaces
- Configuring IO Interfaces
- Programming via IO Interfaces

#### NOTE

Upgrading an existing IO Libraries version preserves the existing installation options. If you wish to modify the installation options, you must re-run the installation after upgrading. (See the “Maintaining Existing Libraries” section for more information on changing installation options after an upgrade.)

### Installing the IO Libraries

Use these steps to **upgrade** existing Agilent IO Libraries to a newer version of the libraries. The steps in this section assume an earlier version of the Agilent IO Libraries is already installed on your PC and you are installing a newer version of the Agilent IO Libraries.

- 1 Turn the PC ON and, as required, install application software such as C/C++, VEE, etc. on your PC.
- 2 Insert the *Agilent IO Libraries for Instrument Control* CD into the CD-ROM drive and wait a few seconds for the application to run.
- 3 The installer should automatically start when the CD is inserted. If not, select **Start | Run** and type `<drive>:setup.exe`, where “drive” is your CD-ROM drive.
- 4 The InstallShield® Wizard appears to begin the Agilent IO Libraries installation.

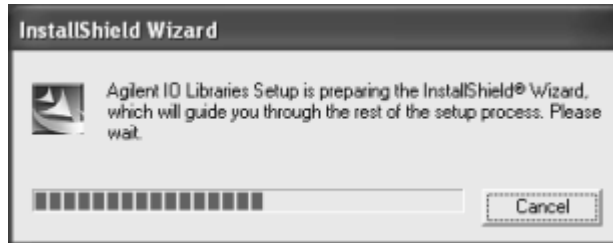

5 After a few seconds, the Title Screen appears.



6 From the Title Screen, click **Next>** to go to the **License Agreement** screen. Click **Yes** to accept the license terms and to display the **Readme Information** screen.

## 2 Installing the Agilent IO Libraries

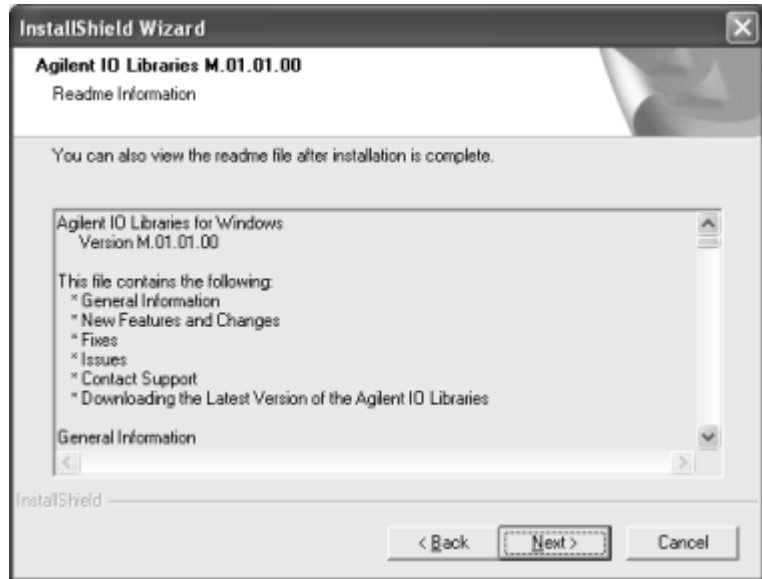

- 7 Scroll through the **Readme Information** screen to display the latest Agilent IO Libraries information. Then, click **Next>** to display the **Current Settings** dialog box.
  - a Agilent highly recommends that you read the **Readme Information** screen for the latest installation information before proceeding further with the installation.
  - b If you do not want to read the **Readme Information** screen at this time, you can return to it after the Agilent IO Libraries are installed by clicking the blue **IO** icon on the Windows taskbar and clicking **View Documentation | IO Libraries Readme**.
- 8 The **Current Settings** dialog box appears. This box shows the (default) paths where SICL and VISA will be installed and the components that will be installed.

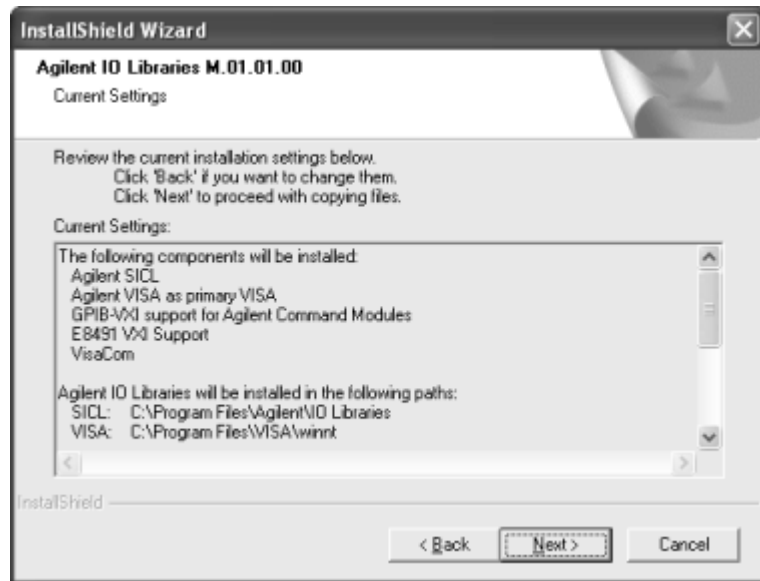

- **To Accept the Settings.** To accept the settings shown, click **Next>**. Setup then installs the files and displays the **Agilent IO Libraries have been successfully installed** screen (see Step 9).
- **To Change the Settings.** To change the settings shown, you first need to complete the upgrade installation and then re-run the Agilent IO Libraries installation. For a Full Installation, see “Installing a Full Version of New Libraries” and for a Custom Installation, see “Installing a Custom Version of New Libraries” for more information.

## Installing IO Interfaces

- 9 As the last step in the Agilent IO Libraries Installation, the **Agilent IO Libraries have been successfully installed** screen appears. Use the guidelines in the following table for the steps to installing any new IO interfaces.

## 2 Installing the Agilent IO Libraries

### NOTE

Before you click **Finish** to install the Agilent IO Libraries, complete step 10, 11, 12, or 13 (as applicable) and step 14 to install IO interfaces.





**Table 14** Steps to Installing New Interfaces

Windows	Hardware	Use Step
98SE/Me/2000/XP/NT	Any IO hardware (except that listed in Steps 12 and 13) that requires a shutdown for installation.	10
98SE/Me/2000/XP/NT	Any IO hardware (except that listed in Steps 12 and 13) that does not require a shutdown for installation.	11
98SE/Me/2000/XP	Agilent 1394 FireWire and E8491B VXI Interface cards	12*
98SE/Me/2000/XP	Agilent 82350 PCI GPIB card	13*

\*Do NOT use Steps 12 or 13 for Windows NT

**10 If an IO Interface Installation Requires Shutdown.** To install and configure IO interfaces that require a power shutdown

- a** If desired, check the **View Readme** box on the **Agilent IO Libraries have been successfully installed** screen.
- b** Click **Finish** to complete the Agilent IO Libraries installation. If you checked the **View Readme** box, the *Agilent IO Libraries Readme* file is displayed.
- c** Remove the *Agilent IO Libraries for Instrument Control* CD from the CD-ROM drive.
- d** Power down your PC, install the IO hardware, and reboot your PC.
- e** Go to Step 14.

### 11 If an IO Interface Installation Does Not Require Shutdown.

To install and configure IO interfaces that do not require a power shutdown:

- a Check the **View Readme** box (if desired) and check the **Run IO Config** box on the **Agilent IO Libraries have been successfully installed** screen.
- b Connect the hardware to your PC and wait for an auto-configure action.
- c If the hardware does not auto-configure, click **Finish** to display the IO Config main screen. If you checked the **View Readme** box, the *Agilent IO Libraries Readme* file is also displayed.
- d Remove the *Agilent IO Libraries for Instrument Control* CD from the CD-ROM drive.
- e Go to Step 14.

### 12 For E8491B VXI Hardware Only. To install and configure an Agilent 1394 FireWire Card connected to an E8491B VXI Interface card in a Windows 98SE/Me/2000/XP operating system:

- a If desired, check the **View Readme** box on the **Agilent IO Libraries have been successfully installed** screen. Then, click **Finish** to complete the Agilent IO Libraries installation. If you checked the **View Readme** box, the *Agilent IO Libraries Readme* file is displayed.
- b Remove the *Agilent IO Libraries for Instrument Control* CD from the CD-ROM drive.
- c Shut down your PC and turn VXI mainframe power OFF.
- d Install an IEEE-1394 FireWire card. Use a FireWire cable to connect the IEEE-1394 card to an E8491B VXI interface card in a VXI mainframe. Then, power up the mainframe and turn your PC ON.
- e As Windows 98SE, Me, 2000, or XP restarts, a **Found New Hardware Wizard** starts. Use the following table for the actions to take for each operating system. Then, go to Step 14.

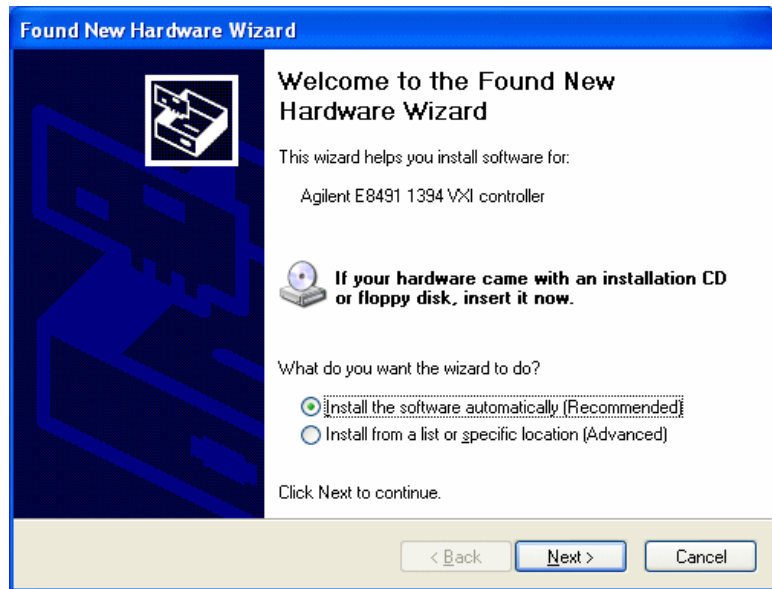
**Table 15** Installing the USB Driver

OS	Action
98SE	If the Wizard asks for the <i>1394.sys</i> file, provide the CD for the Windows 98SE operating system and let the Wizard search for and install the file. When the Wizard asks for the IO Libraries CD, provide the CD or continue to where the Wizard asks for the <i>1394ipt.sys</i> file. Browse to <code>C:\Winnt\system32\drivers\</code> and click <b>OK</b> .
Me	When the Wizard asks for the IO Libraries CD, provide the CD or continue to where the Wizard asks for the <i>1394ipt.sys</i> file. Browse to <code>C:\Winnt\system32\drivers\</code> and click <b>OK</b> .
2000/XP	Click <b>Next&gt;</b> to accept the default suggestions. Click <b>Finish</b> to complete the installation.

- 13 For 82350 PCI GPIB Hardware Only.** To configure a Windows 98SE/Me/2000/XP operating system that has an Agilent 82350 PCI GPIB Card installed in the PC:
- If desired, check the **View Readme** box on the **Agilent IO Libraries have been successfully installed** screen. Then, click **Finish** to complete the Agilent IO Libraries installation. If you checked the **View Readme** box, the *Agilent IO Libraries Readme* file is displayed.
  - Remove the *Agilent IO Libraries for Instrument Control* CD from the CD-ROM drive.
  - Shut down the PC and install the 82350 in a PCI slot. Then, power up the mainframe and turn the PC ON. As Windows 98SE/Me/2000/XP restarts, a **Found New Hardware Wizard** starts.



- Use the following table for the actions to take for each operating system. Then, go to Step 14.

**Table 16** Installing the Agilent IO Libraries

OS	Action
98SE/Me	When the Wizard asks for the <b>Agilent IO Libraries</b> CD, click <b>OK</b> . When the Wizard asks for the <i>hpioclas.dll</i> file, browse to C : \ windows \ system \ and click <b>OK</b> .
2000/XP	Click <b>Next&gt;</b> to accept the default suggestions. Click <b>Finish</b> to complete the installation.

**14** At this point, the IO Libraries and necessary IO hardware have been installed. You may still need to configure the installed interfaces.

## Configuring IO Interfaces

To configure the IO interfaces, run IO Config by clicking the blue **IO** icon and clicking **Run IO Config**. Follow the on-screen instructions to configure the interface. See [Chapter 4](#), “Using IO Configuration Utilities” for information on using IO Config.

## Programming via IO Interfaces

You can use VISA Assistant to communicate between your PC and instruments. See [Chapter 4](#), “Using IO Configuration Utilities” for information on VISA Assistant.

To begin programming via the interface using Agilent VISA or SICL, see [Chapter 5](#), “Configuring IO Interfaces.”

For information on using Agilent VISA, see the *Agilent VISA User’s Guide for Windows*. For information on SICL, see the *Agilent SICL User’s Guide for Windows*. Both documents are available in electronic form by clicking the blue **IO** icon on the Windows taskbar and clicking **View Documentation**.

### Maintaining Existing Libraries

This section provides suggested steps for working with existing Agilent IO Libraries, including:

- Modifying Existing Libraries
- Repairing Existing Libraries
- Removing Existing Libraries

#### Modifying Existing Libraries

This section provides suggested steps for modifying existing Agilent IO Libraries.

- 1 Turn your PC ON, insert the *Agilent IO Libraries for Instrument Control* CD into the CD-ROM drive and wait a few seconds for the application to run.
- 2 The installer should automatically start when the CD is inserted. If not, select **Start | Run** and type `<drive>:setup.exe`, where “drive” is your CD-ROM drive.
- 3 The InstallShield Wizard appears to begin the Agilent IO Libraries modification process.

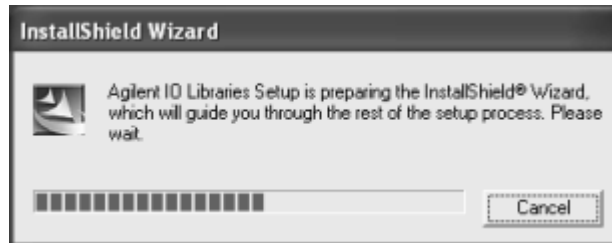

- 4 After a few seconds, the Setup Maintenance screen appears. From this screen, select **Modify** and then click **Next>** to display the Tree View screen.



- 5 When the Tree View screen appears, select the components you want to install and clear the components you do not want to install. Then, click **Next>** to begin the (modified) installation.

## 2 Installing the Agilent IO Libraries

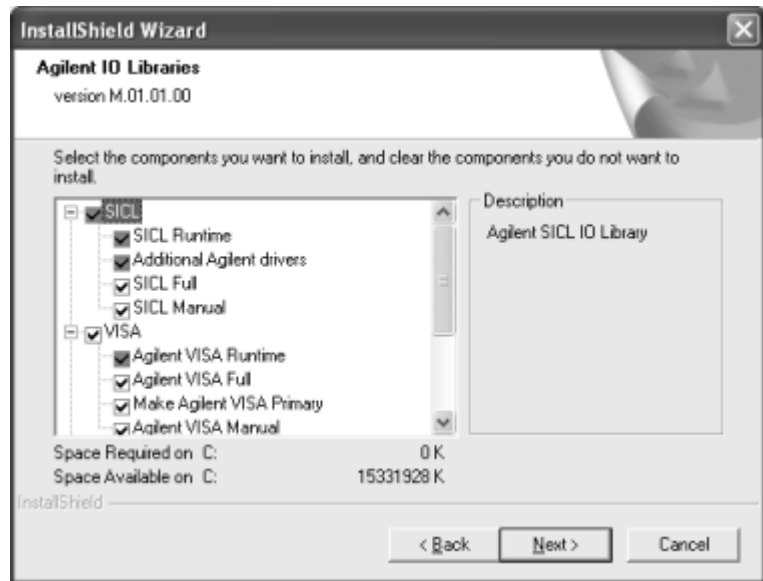

- 6 Setup then installs/clears items you selected. When the **Agilent IO Libraries have been successfully installed** screen appears, you can click **Finish** to complete the process.
  - a If desired, check the **View Readme** box on the **Agilent IO Libraries have been successfully installed** screen. Then, click **Finish** to complete the Agilent IO Libraries installation. If you checked the **View Readme** box, the *Agilent IO Libraries Readme* file is displayed.
  - b If you want to configure interfaces, click **Run IO Config** and then click **Finish**. See [Chapter 4](#), “Using IO Configuration Utilities” for information on the IO Config utility.



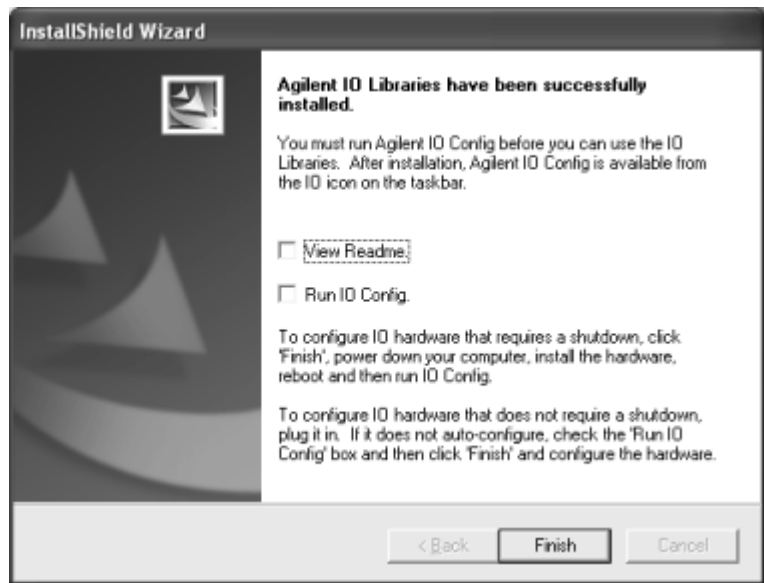

- 7 Remove the *Agilent IO Libraries for Instrument Control* CD from the CD-ROM drive.

## Repairing Existing Libraries

This section provides suggested steps for repairing existing Agilent IO Libraries.

- 1 Turn the PC ON, insert the *Agilent IO Libraries for Instrument Control* CD into the CD-ROM drive and wait a few seconds for the application to run.
- 2 The installer should automatically start when the CD is inserted. If not, select **Start | Run** and type `<drive>:setup.exe`, where “drive” is your CD-ROM drive.

## 2 Installing the Agilent IO Libraries

- 3 The InstallShield Wizard appears to begin the Agilent IO Libraries repair process.

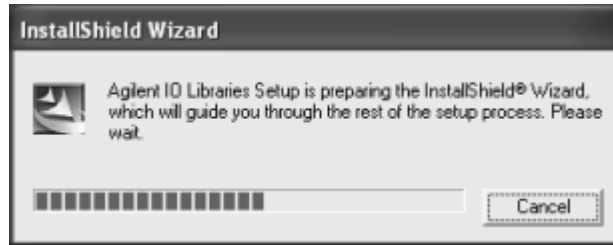

- 4 After a few seconds, the IO Libraries Setup Maintenance screen appears. From this screen, select **Repair** and then click **Next>** to reinstall all IO Libraries components installed by the previous setup.



- 5 Setup then replaces any missing Agilent IO Libraries files. When the **Agilent IO Libraries have been successfully installed** screen appears, you can click **Finish** to complete the process.
  - a If desired, check the **View Readme** box on the **Agilent IO Libraries have been successfully installed** screen. Then, click **Finish** to complete the Agilent IO Libraries installation. If you checked the **View Readme** box, the *Agilent IO Libraries Readme* file is displayed.
  - b If you want to configure interfaces, click **Run IO Config** and then click **Finish**. See [Chapter 4](#), “Using IO Configuration Utilities” for information on the IO Config utility.
- 6 Remove the *Agilent IO Libraries for Instrument Control* CD from the CD-ROM drive.



### Removing Existing Libraries

This section provides suggested steps for removing existing Agilent IO Libraries.

- 1 Turn the PC ON, insert the *Agilent IO Libraries for Instrument Control* CD in the CD-ROM drive and wait a few seconds for the application to run.
- 2 The installer should automatically start when the CD is inserted. If not, select **Start | Run** and type `<drive>:setup.exe`, where “drive” is your CD\_ROM drive.
- 3 The InstallShield Wizard appears to begin the Agilent IO Libraries removal process.

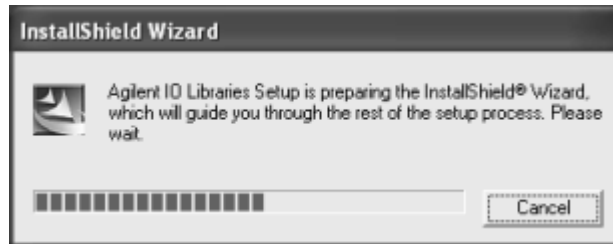

- 4 After a few seconds, the IO Libraries Setup Maintenance screen appears. From this screen, select **Remove** and then click **Next>** to remove the current IO Libraries installation.



- 5 The **Confirm Delete** screen appears. Click **Yes** to delete all currently installed Agilent IO Libraries components.
- 6 When component removal is complete, the **Agilent IO Libraries have been successfully removed** screen appears. Click **Finish** to complete the process.

## 2 Installing the Agilent IO Libraries



7 Remove the CD from the CD-ROM drive.

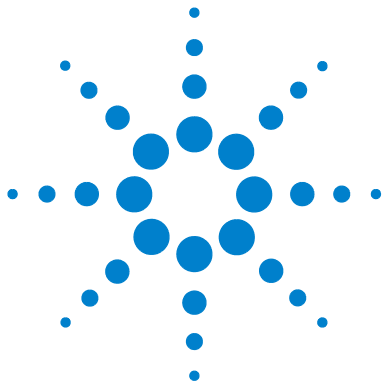

### 3 Agilent IO Libraries Description



## Agilent IO Libraries Description

This chapter provides a description of the Agilent IO Libraries, as well as details concerning their proper installation, including:

- Agilent IO Libraries Components
- Agilent IO Libraries Items Created
- Agilent IO Libraries System Information

### Agilent IO Libraries Components

The Agilent IO Libraries software consists of two libraries and four IO configuration utilities.

- Libraries
  - *Agilent Virtual Instrument Software Architecture (VISA)*
  - *Agilent Standard Instrument Control Library (SICL)*
- IO Configuration Utilities
  - IO Config
  - VISA Assistant
  - VXI Resource Manager
  - LAN Server

#### NOTE

Since VISA and SICL are different libraries, using VISA functions and SICL functions in the same IO application is not supported.

### Agilent VISA Description

*Agilent Virtual Instrument Software Architecture (VISA)* is an IO library that can be used to develop IO applications and instrument drivers that comply with the *VXIplug&play* standards. Applications and instrument drivers developed with VISA can execute on *VXIplug&play* system frameworks that have the VISA IO layer. Therefore, software from different vendors can be used together on the same system.



Use VISA if you want to use *VXIplug&play* instrument drivers in your applications, or if you want the IO applications or instrument drivers that you develop to be compliant with *VXIplug&play* standards. If you are using new instruments or are developing new IO applications or instrument drivers, Agilent recommends you use Agilent VISA.

### VISA Support

The 32-bit version of VISA is supported on this version of the Agilent IO Libraries for Windows 98SE/Me/2000/XP/NT. Support for the 16-bit version of VISA was removed in version H.01.00. However, versions through G.02.02 support 16-bit VISA. C, C++, and Visual Basic (up to version 6.0) are supported on all these Windows versions.

### VISA Users

VISA has two specific types of users. The first type is the instrumentation end user who wants to use *VXIplug&play* instrument drivers in his or her applications. The second type of user is the instrument driver or IO application developer who wants to be compliant with *VXIplug&play* standards.

Software development using VISA is intended for instrument IO and C/C++ or Visual Basic programmers who are familiar with Windows 98SE/Me/2000/XP/NT. To perform VISA installation and configuration on Windows 2000, XP, or NT, you must have system administration privileges on the applicable system.

### VISA Documentation

This table shows associated documentation you can use when programming with Agilent VISA.

**Table 1** Documentation Available When Programming Agilent VISA

Document	Description
Agilent VISA User's Guide	Shows how to use Agilent VISA and provides the VISA language reference.

**Table 1** Documentation Available When Programming Agilent VISA

Document	Description
VISA Online Help	Information is provided in the form of Windows Help.
VISA Example Programs	Example programs are provided online to help you develop VISA applications.
<i>VXIplug&amp;play System Alliance VISA Library Specification 4.3</i>	Specifications for VISA.
IEEE Standard Codes, Formats, Protocols, and Common Commands	ANSI/IEEE Standard 488.2-1992.
VXIbus Consortium specifications (when using VISA over LAN)	<i>TCP/IP Instrument Protocol Specification - VXI-11, Rev. 1.0</i> <i>TCP/IP-VXIbus Interface Specification - VXI-11.1, Rev. 1.0</i> <i>TCP/IP-IEEE 488.1 Interface Specification - VXI-11.2, Rev. 1.0</i> <i>TCP/IP-IEEE 488.2 Instrument Interface Specification - VXI-11.3, Rev. 1.0</i>

## Agilent SICL Description

*Agilent Standard Instrument Control Library (SICL)* is an IO library developed by Agilent that is portable across many IO interfaces and systems. IO applications using this library can be ported at the source code level from one system to another with few (or no) changes. You can use Agilent SICL if you have been using SICL and want to remain compatible with software currently implemented in SICL.

### SICL Support

The 32-bit version of SICL is supported on this version of the Agilent IO Libraries for Windows 98SE/Me/2000/XP/NT. Support for the 16-bit version of SICL was removed in version

H.01.00. However, versions through G.02.02 support 16-bit SICL. C, C++, and Visual Basic are supported on all these Windows versions.

### SICL Users

SICL is intended for instrument IO and C/C++ or Visual Basic programmers who are familiar with Windows 98SE/Me/2000/XP/NT. To perform SICL installation and configuration on Windows 2000, XP, or NT, you must have system administration privileges on the applicable system.

### SICL Documentation

This table shows associated documentation you can use when programming with Agilent SICL.

**Table 2** Documentation Available for Programming SICL

Document	Description
Agilent SICL User's Guide for Windows	Shows how to use Agilent SICL and provides the SICL language reference.
SICL Online Help	Information is provided in the form of Windows Help.
SICL Example Programs	Example programs are provided online to help you develop SICL applications.
VXIbus Consortium specifications (when using VISA over LAN)	<i>TCP/IP Instrument Protocol Specification - VXI-11, Rev. 1.0</i> <i>TCP/IP-VXIbus Interface Specification - VXI-11.1, Rev. 1.0</i> <i>TCP/IP-IEEE 488.1 Interface Specification - VXI-11.2, Rev. 1.0</i> <i>TCP/IP-IEEE 488.2 Instrument Interface Specification - VXI-11.3, Rev. 1.0</i>

## IO Config Description

The IO Config utility is used by the Agilent IO Libraries to configure instrument IO hardware interfaces. An interface must be configured with IO Config before the interface can be used

with the IO Libraries. You can configure all available interfaces with IO Config for use with the Agilent IO Libraries. With IO Config, you can also add, edit, or remove configuration entries for the interface(s) you specify.

IO Config is an interactive program that searches your system for installed interfaces that VISA and SICL support. You select the interface(s) you want to configure and IO Config selects default parameters required to configure the interface(s).

You can run IO Config at any time. However, you must first install an interface card in your system before you can configure the interface. IO Config verifies that an interface card is installed before a configuration entry is added for the card.

You must have system administrator privileges on Windows 2000/XP/NT to run IO Config. You may also need to reboot the computer if you add or modify interfaces with IO Config to load or update driver files for specific interfaces in the Windows kernel. IO Config informs you if it is necessary to reboot your computer.

## VISA Assistant Description

VISA Assistant is an application program that uses the Agilent IO Libraries to communicate with and control VXI, GPIB, and serial Instruments.

VISA Assistant can automatically detect and assign *VXIplug&play* instrument drivers to instruments. VISA Assistant can also be used to send and receive strings to instruments which support formatted IO. For other instruments, VISA Assistant allows you to read and write memory areas. VISA Assistant also describes attributes that are associated with an instrument.

## VXI Resource Manager Description

If your system includes an E8491 IEEE-1394 PC Link to VXI interface, you can view the output of the VXI Resource Manager to determine if your system is properly configured. The easiest way to view this output is to use the IO Config utility to run the VXI Resource Manager.

The VXI Resource Manager initializes and prepares the VXI system for use. The VXI Resource Manager runs when:

- VXI mainframe power is applied or cycled
- The E8491 Reset button is pressed
- It is activated from the IO Config utility
- It is activated from the Agilent IO Libraries Control **IO** icon
- The computer is rebooted

In VXI systems with multiple E8491s, individual mainframes can be turned off without affecting other mainframes in the system. When a mainframe is turned on, the VXI Resource Manager reconfigures the mainframe.

## LAN Server Description

If you configured the LAN server on your system using IO Config, you must now start the LAN server process on the system. To start the LAN server, you can *either* restart (reboot) your system now, or manually start the LAN server process on your system.

On Windows 2000/XP/NT, the LAN Server must be started manually or you must place a shortcut to it in the Windows Startup folder to have it start when you log in.

## Agilent IO Libraries Items Created

During the Agilent IO Libraries installation, SICL and/or VISA and the IO configuration utilities are installed and several program icons are created. In addition, an Agilent IO Libraries Control is created.

### Agilent IO Libraries Control Icon

During installation, an Agilent IO Libraries Control icon is created. This icon is located on the Windows taskbar and is shown as a blue **IO** symbol. Clicking this icon and then selecting **View Documentation** displays the menu shown in the figure that follows.

Clicking **View Documentation | Installation and Path Information** displays the IO Libraries, VISA, and Registry installation paths. This is primarily useful for troubleshooting installation problems.

#### NOTE

If the IO Libraries Control icon is not visible, you can display the icon by clicking **Start | Programs | Agilent IO Libraries | IO Control**.

---

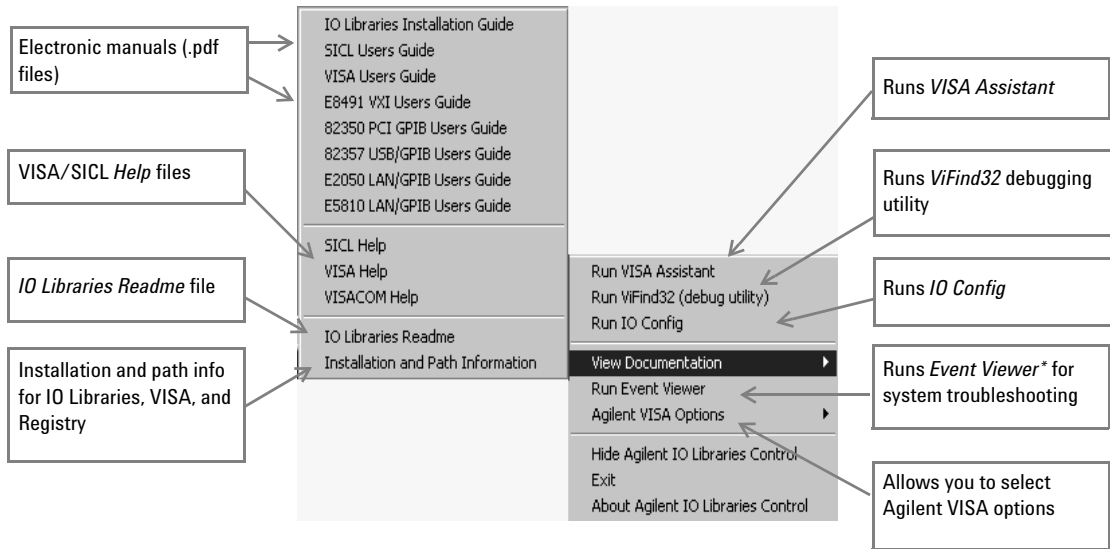

\*Event Viewer is called Message Viewer in Windows 98SE and Me

#### Run VISA Assistant

Clicking the **IO** icon on the taskbar and then clicking **Run VISA Assistant** displays the VISA Assistant main screen. See “Using VISA Assistant” in [Chapter 3](#), “Agilent IO Libraries Description” for details on VISA Assistant.

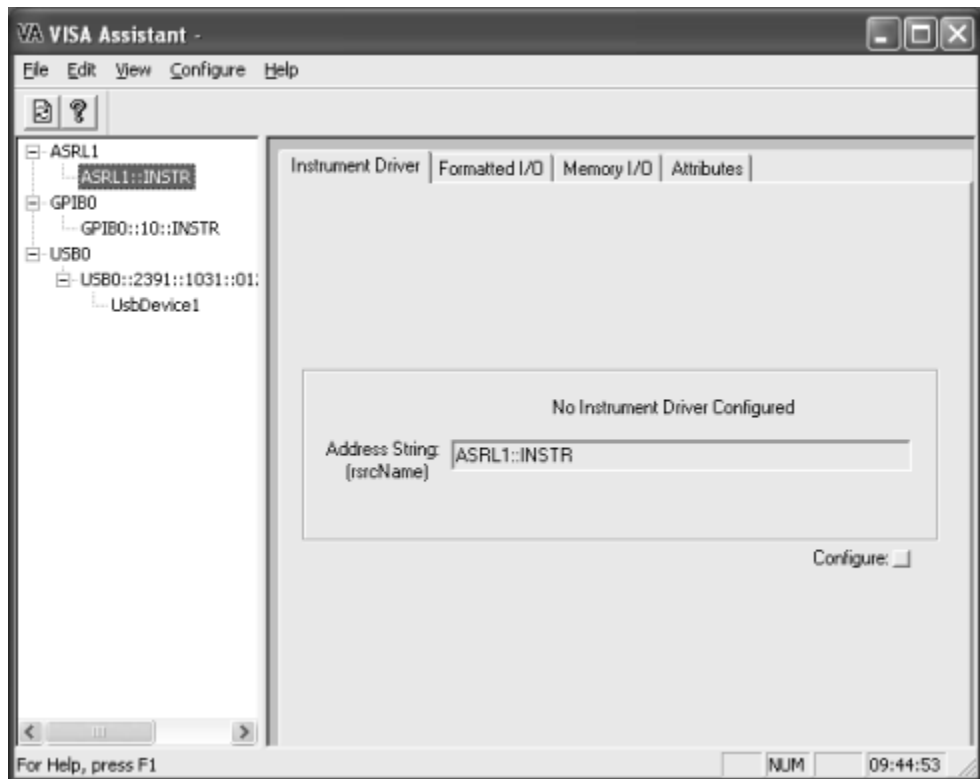



### Run ViFind32

Clicking the **IO** icon on the taskbar and then clicking **Run ViFind32 (debug utility)** opens ViFind32 in a console window. ViFind32 lists all VISA resources found. Pressing the Enter key exits ViFind32 and closes the console window.

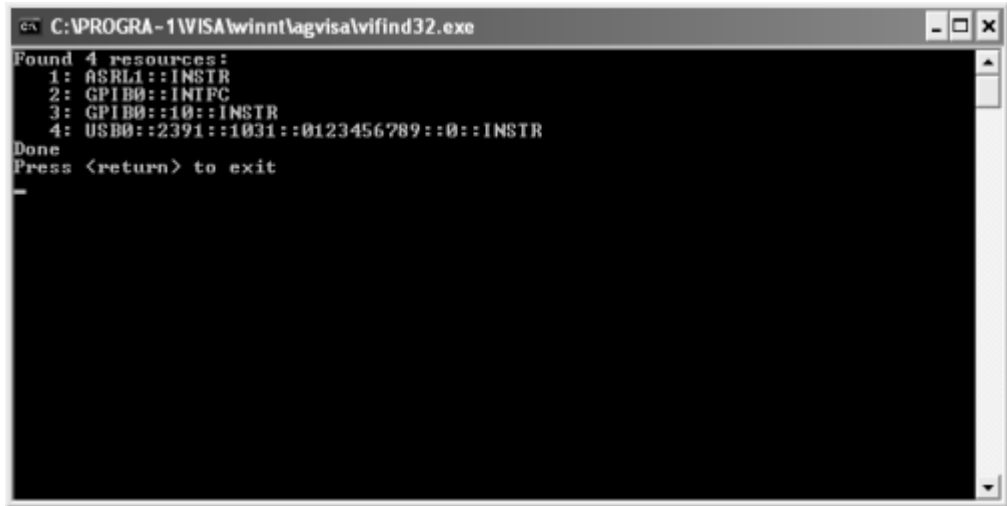
A screenshot of a Windows console window titled "C:\PROGRA-1\WISALwinnt\agvisalvifind32.exe". The window has a black background with white text. The text displays the results of a VISA resource search, listing four resources: 1: ASRL1::INSTR, 2: GPIB0::INTFC, 3: GPIB0::10::INSTR, and 4: USB0::2391::1031::0123456789::0::INSTR. Below the list, it says "Done" and "Press <return> to exit".

```
C:\PROGRA-1\WISALwinnt\agvisalvifind32.exe
Found 4 resources:
1: ASRL1::INSTR
2: GPIB0::INTFC
3: GPIB0::10::INSTR
4: USB0::2391::1031::0123456789::0::INSTR
Done
Press <return> to exit
```

#### Run IO Config

Clicking the **IO** icon on the taskbar and then clicking **Run IO Config** displays the IO Config main screen. See “Using IO Config” in [Chapter 4](#), “Using IO Configuration Utilities” for details on the IO Config utility.

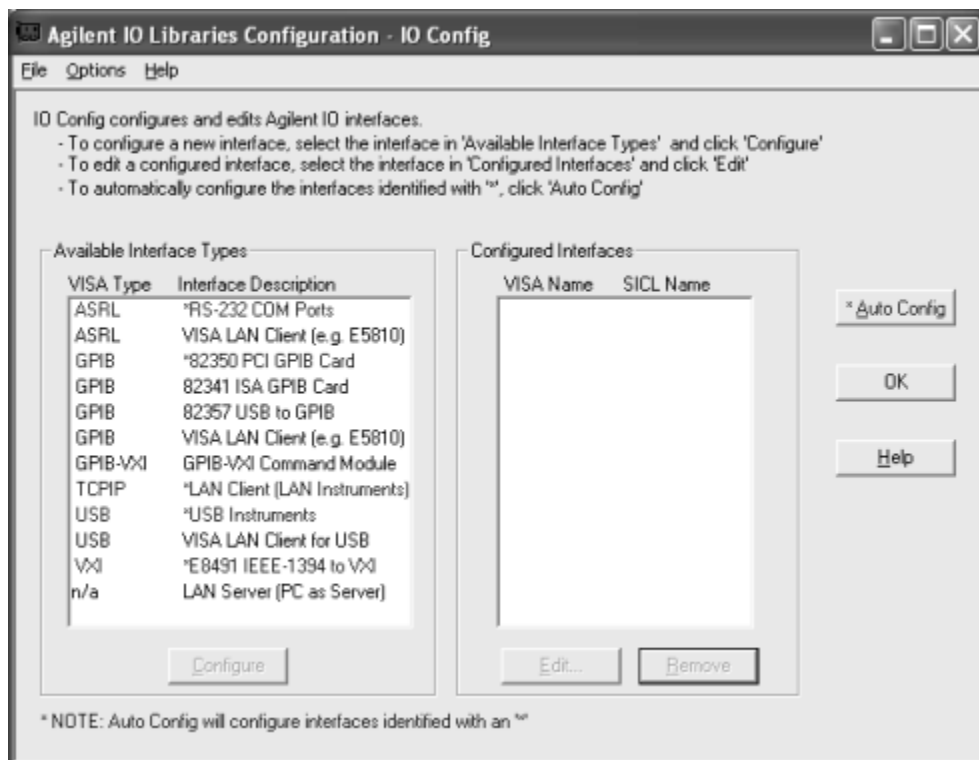

## View Documentation

Clicking the **IO** icon on the taskbar and then clicking **View Documentation** displays four types of documentation: Electronic (PDF) manuals, Help Files, IO Libraries Readme, and Installation and Path Information.

- **Electronic (PDF) Files.** If Adobe Acrobat Reader is installed on your PC, clicking the applicable line displays a .pdf version of the manual selected. For example, clicking **VISA Users Guide** displays a .pdf version of the *Agilent VISA User's Guide*.

### NOTE

Adobe Acrobat Reader is required to view manuals available from the Agilent IO Libraries Control. (Online Help files and the Readme file do not require Acrobat Reader.) If Adobe Acrobat Reader is not present, no error message appears, but manuals will not be displayed.

- **Help Files.** Clicking the applicable line displays the online Help file for Agilent VISA or Agilent SICL. Adobe Acrobat Reader is not required to view the Help files.
- **IO Libraries Readme.** Clicking **IO Libraries Readme** displays the *Agilent IO Libraries General Information (Readme)* file for the current release. Consult the *Readme* file for the latest information on your version of the Agilent IO Libraries.
- **Installation and Path Information.** Clicking **Installation and Path Information** displays the **Agilent IO Libraries Installation and Path Information** dialog box.

#### RunEvent Viewer

Clicking the **IO** icon on the taskbar and then clicking **Run Event Viewer** displays the Windows Event Viewer that you can use to troubleshoot your system.

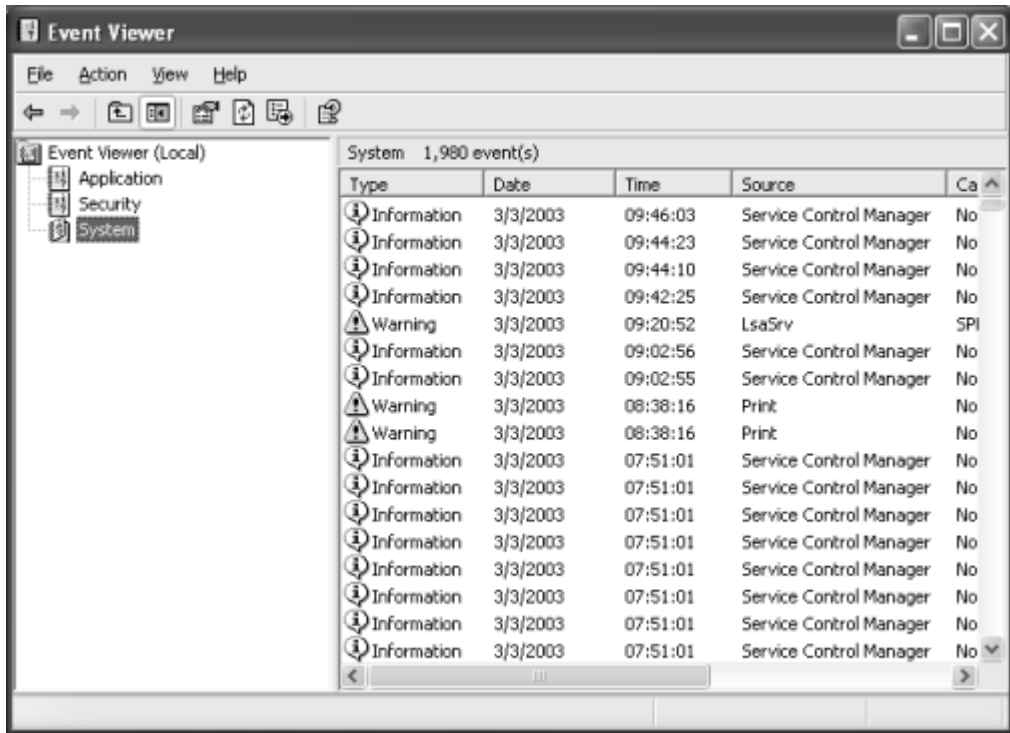

#### NOTE

SICL messages (including messages logged from VISA) may appear in both the Application Log and System Log sections of the Event Viewer.

## Agilent VISA Options

Clicking the **IO** icon and then clicking **Agilent VISA Options** displays **VISA Logging** and **Default VISA LockWait**.

**VISA Logging.** VISA Logging has three options:

- **Off:** (Default)
- **Event Viewer:** For Windows 2000/XP/NT, messages are logged to the *Event Viewer*. (For Windows 98SE and Me, messages are logged to the *Message Viewer* application.)
- **Debug Window:** Messages are logged using Windows OutputDebugString(). (This is useful in debuggers.)

**Default VISA LockWait.** This sets the default value for the Agilent-specific VISA ViBoolean local (per-session) attribute VI\_AGATTR\_LOCKWAIT. When a lock-abiding VISA call is made on a session to an exclusively locked resource:

- If VI\_AGATTR\_LOCKWAIT is VI\_FALSE (Default VISA LockWait **False** is checked), the call is immediately returned with a VI\_ERROR\_RSRC\_LOCKED.
- If VI\_AGATTR\_LOCKWAIT is VI\_TRUE (Default VISA LockWait **True** is checked), the call waits for the session timeout interval for the lock to be released and then returns a VI\_ERROR\_TMO rather than a VI\_ERROR\_RSRC\_LOCKED.

#### Hide Agilent IO Libraries Control

Clicking the **IO** icon and then clicking **Hide Agilent IO Libraries Control** causes the blue **IO** icon to disappear from the Windows taskbar. You can restore the **IO** icon to the taskbar by clicking **Start | Programs | Agilent IO Libraries | IO Control**.

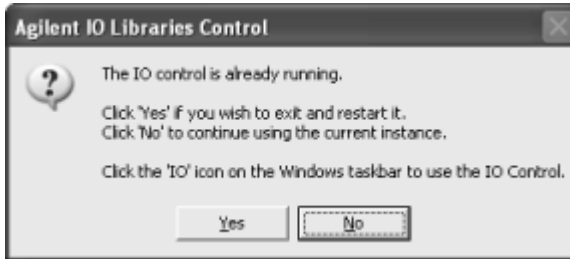

If you can see the **IO** icon on the taskbar, click **No**, then click the **IO** icon to use it. If you do not see the **IO** icon on the taskbar, or if you wish to exit and restart it, click **Yes**.

#### Exit

Clicking the **IO** icon and then clicking **Exit** displays the **Agilent IO Libraries Control** dialog box. Click **Yes** to terminate the IO Control and cause the blue **IO** icon to disappear from the Windows taskbar. You can restore the **IO** icon to the taskbar by clicking **Start | Programs | Agilent IO Libraries | IO Control**.



### About Agilent IO Libraries Control

Clicking the **IO** icon and then clicking **About Agilent IO Libraries Control** displays the **Agilent IO Libraries Control** dialog box that shows the currently installed version of the libraries and whether or not Agilent SICL and/or Agilent VISA are installed. For example, this dialog box shows the Version M.01.01.00 is installed, Agilent SICL is installed, and Agilent VISA is installed as the primary VISA.



If you have installed a Runtime version of the IO Libraries (*IOLibsRT.exe*), the following displays:



#### NOTE

You will only see the above "Runtime" dialog box if you installed from *IOLibsRT.exe*. You will not see this if you simply chose the "Runtime" option from a Full version of the install.

## Program Groups Created

During installation, the Agilent IO Libraries program group is created. After the libraries are installed, to access this group click **Start | Programs | Agilent IO Libraries** to display the following icons.

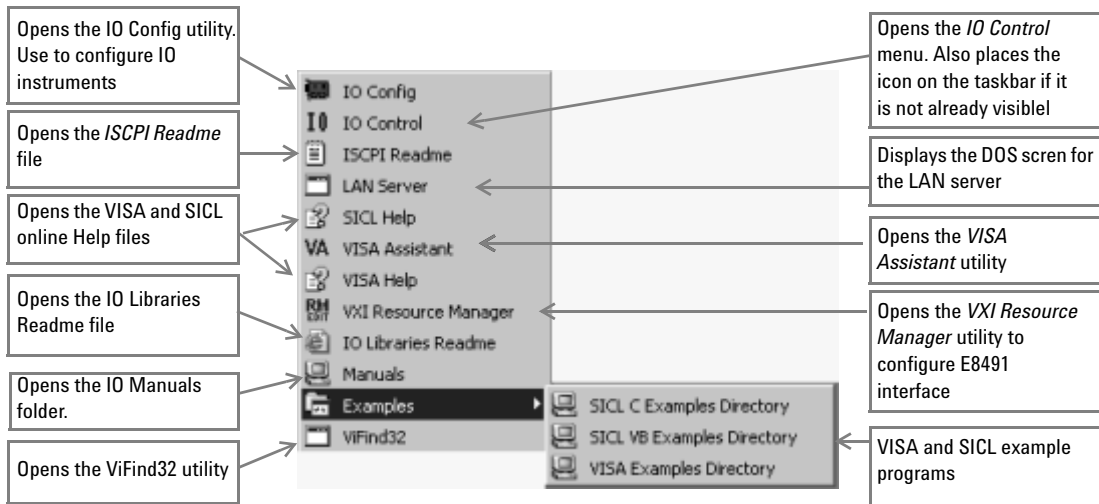

Three utilities are installed that you can use with the IO Libraries: IO Config, VISA Assistant, and VXI Resource Manager. See [Chapter 4](#), “Using IO Configuration Utilities” for information on using these utilities.

## Access to Previous Versions

The *Agilent IO Libraries for Instrument Control* CD also includes previous versions of the Agilent IO Libraries.



### What's in the Previous Versions Directory?

For example, as shown in the following figure, the M.01.01.00 version of the CD includes previous versions G.02.02.02, H.01.02.00, J.02.00.01, K.01.00.00, L.01.01.00, and L.02.01.00. The directory also includes information on supported interfaces and previous revision history.

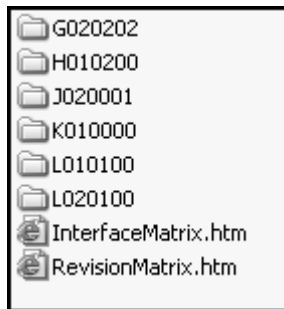

### Installing a Previous Version to Your PC

To install a previous version of the Agilent IO Libraries on your PC:

- 1 Turn the PC ON, insert the *Agilent IO Libraries for Instrument Control* CD into the CD-ROM drive, and wait a few seconds for the application to run.
- 2 The installer should automatically start when the CD is inserted. If not, click **Start | Run** and type <drive>:setup.exe, where “drive” is your CD-ROM drive.

### 3 Agilent IO Libraries Description

- 3 The InstallShield® Wizard appears to begin the Agilent IO Libraries installation. *Immediately* click the **Cancel** button to stop the installation.

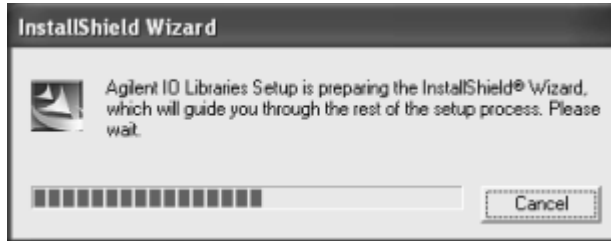

- 4 Uninstall the currently installed version of the Agilent IO Libraries. (You cannot install an earlier version of the libraries over a later version.)
- 5 Open your Windows Explorer and navigate to <drive> | PrevRevs | <version>, where “version” is the version (G020202, H010200, etc.) that you want to copy.
- 6 Run the Setup.exe program from that directory.
- 7 Remove the *Agilent IO Libraries for Instrument Control* CD from the CD-ROM drive.

## Agilent IO Libraries System Information

This section describes Agilent IO Libraries minimum system requirements, supported interfaces, and previous revisions information. You should verify that your system meets the minimum requirements shown and the system interfaces are supported before you install the Agilent IO Libraries.

### Minimum System Requirements

The following table summarizes **minimum** hardware and software requirements to install and use the Agilent IO Libraries. Adding additional RAM may improve overall system performance.

**Table 3** Minimum System Requirements

Item	Minimum Requirements
<b>Hardware Requirements</b>	
PC Operation/Memory	100 MHz operation and 64 Mb RAM
Microsoft Windows compatible	With available slot for purchased hardware.
<b>Software Requirements</b>	
Operating System	Windows 98SE/Me/2000/XP Home and Professional/NT
IO Library Installation Sizes	<ul style="list-style-type: none"> <li>- Runtime (adds hw drivers): 24 Mb</li> <li>- Full (without manuals): 29 Mb</li> <li>- Full (with manuals): 45 Mb</li> <li>- Add Adobe Acrobat Reader 5.05: 16 Mb addl</li> </ul>

\*If you use an RS-232 interface with VISA and SICL, see the RS-232 documentation for your Windows product, since VISA and SICL use the RS-232 capabilities built into Windows.

## Agilent IO Libraries Supported Interfaces

This table shows the version of the Agilent IO Libraries recommended for each IO interface and operating system used for 32-bit applications (16-bit applications are not supported).

**Table 4** Supported Interfaces

Interface		Windows Operating Systems							
Type	Product	XP	2000	NT 4.0	NT 3.51	Me	98SE	95	3.1
USB	USB Instruments*	M.01.01 Single or Dual CPU	M.01.01 Single or Dual CPU	No	No	M.01.01	M.01.01	No	No
	82357A GPIB	M.01.01 Single or Dual CPU	M.01.01 Single or Dual CPU	No	No	M.01.01	M.01.01	No	No
PCI	82350B 5V PCI GPIB	M.01.01 Single or Dual CPU	M.01.01 Single or Dual CPU	M.01.01 Single or Dual CPU	No	M.01.01	M.01.01	No	No
	82350A GPIB	M.01.01 Single or Dual CPU	M.01.01 Single or Dual CPU	M.01.01 Single or Dual CPU	No	M.01.01	M.01.01	K.01.00	No
LAN	E5810A GPIB RS-232	M.01.01 Single or Dual CPU	M.01.01 Single or Dual CPU	M.01.01 Single or Dual CPU	No	M.01.01	M.01.01	No	No
	E2050A/B GPIB	M.01.01 Single or Dual CPU	M.01.01 Single or Dual CPU	M.01.01 Single or Dual CPU	G.02.02	M.01.01	M.01.01	K.01.00	No

**Table 4** Supported Interfaces

Interface		Windows Operating Systems							
Type	Product	XP	2000	NT 4.0	NT 3.51	Me	98SE	95	3.1
ISA	82341C GPIB	No	M.01.01	M.01.01	G.02.02	No	M.01.01	K.01.00	B.03.13
	82335B GPIB	No	No	No	No	No	No	G.02.02 SICL only, not recommended	B.03.13
	82341D GPIB	No	No	No	No	No	No	J.02.00	No
	E2075A GPIO	No	K.01.00 - SICL Only	K.01.00 - SICL Only	G.02.02 SICL only	No	K.01.00 - SICL Only	K.01.00 - SICL Only	B.03.13 - SICL Only
Serial	RS-232	M.01.01 Single or Dual CPU	M.01.01 Single or Dual CPU	M.01.01 Single or Dual CPU	G.02.02	M.01.01	M.01.01	K.01.00	B.03.13
VXI	E1406A GPIB	M.01.01	M.01.01	M.01.01	G.02.02	M.01.01	M.01.01	K.01.00	B.03.13
	E8491A/B IEEE-1394 FireWire	M.01.01 Single or Dual CPU	M.01.01 Single or Dual CPU	M.01.01 Single or Dual CPU	No	M.01.01	M.01.01	K.01.00	No
	E623x Embedded Pentium	No	No	G.02.02 or H.01.02	No	No	No	G.02.02 or H.01.02	No
	E985x Embedded Pentium	No	No	H.01.03	No	No	No	No	No

\*USB instruments are those that support the USBTMC or USBTMC-USB488 specifications

## Agilent IO Libraries Revisions

This table summarizes major Agilent IO Libraries revisions with their supported interfaces and Windows operating systems.

**Table 5** Table of IO Library Revisions

IO Libraries Revision	Windows Operating Systems	Supported Interfaces	Notes
<b>M.01.01</b>	98SE	USB Instruments*	<b>Added Support:</b> <ul style="list-style-type: none"> <li>• USB Instruments*</li> <li>• VISA-COM installed with IO Libraries</li> </ul>
	Me	82357A USB/GPIB Interface	
	NT 4.0	82350B 5V PCI GPIB Interface	
	2000	82350A PCI GPIB Interface	
	XP	E5810A LAN/GPIB Gateway E2050A/B LAN/GPIB Gateway 82341C ISA GPIB Interface (Win 98SE, NT 4.0, 2000 only) E1406A VXI Command Module (GPIB) E8491B VXI IEEE 1394 Slot 0 (FireWire) RS-232	
<b>L.02.01</b>	98SE	82357A USB/GPIB Interface	<b>Added Support:</b> <ul style="list-style-type: none"> <li>• 82350B 5V PCI GPIB</li> </ul>
	Me	82350B 5V PCI GPIB Interface	
	NT 4.0	82350A PCI GPIB Interface	
	2000	E5810A LAN/GPIB Gateway	
	XP	E2050A/B LAN/GPIB Gateway 82341C ISA GPIB Interface (Win 98SE, NT 4.0, 2000 only) E1406A VXI Command Module (GPIB) E8491B VXI IEEE 1394 Slot 0 (FireWire) RS-232	
<b>L.02.00</b>	98SE	82357A USB/GPIB Interface	<b>Added Support:</b> <ul style="list-style-type: none"> <li>• Agilent T&amp;M Programmers Toolkit for Visual Studio.NET</li> <li>• VISA locking over TCPIP</li> </ul> <b>No Longer Supports:</b> <ul style="list-style-type: none"> <li>• Building IO projects with Microsoft Visual Studio 5 and earlier, due to a change in the .lib file format.</li> </ul>
	Me	82350A PCI GPIB Interface	
	NT 4.0	E5810A LAN/GPIB Gateway	
	2000	E2050A/B LAN/GPIB Gateway	
	XP	82341C ISA GPIB Interface (Win 98SE, NT 4.0, 2000 only) E1406A VXI Command Module (GPIB) E8491B VXI IEEE 1394 Slot 0 (FireWire) RS-232	

**Table 5** Table of IO Library Revisions

<b>IO Libraries Revision</b>	<b>Windows Operating Systems</b>	<b>Supported Interfaces</b>	<b>Notes</b>
<b>L.01.01</b>	98SE Me NT 4.0 2000 XP	82357A USB/GPIB Interface 82350A PCI GPIB Interface E5810A LAN/GPIB Gateway E2050A/B LAN/GPIB Gateway 82341C ISA GPIB Interface (Win 98SE, NT 4.0, 2000 only) E1406A VXI Command Module (GPIB) E8491B VXI IEEE 1394 Slot 0 (FireWire) RS-232	<b>Added Support:</b> <ul style="list-style-type: none"> <li>• E5810A LAN?GPIB Gateway</li> <li>• Windows XP</li> <li>• 82357A USB/GPIB Interface</li> </ul> <b>No Longer Supports:</b> <ul style="list-style-type: none"> <li>• Windows 95</li> <li>• E2075A GPIO</li> </ul>
<b>L.01.00</b>	98SE Me NT 4.0 2000 XP	82341C ISA GPIB Interface (98SE, NT 4.0, 2000 only) 82350A PCI GPIB Interface 82357A USB/GPIB Interface E2050A/B LAN/GPIB Gateway E1406A VXI Command Module (GPIB) E8491B VXI IEEE 1394 Slot 0 (FireWire) RS-232	<b>Added Support:</b> <ul style="list-style-type: none"> <li>• Windows XP</li> <li>• 82357A USB/GPIB Interface</li> </ul> <b>No Longer Supports:</b> <ul style="list-style-type: none"> <li>• Windows 95</li> <li>• E2075A GPIO</li> </ul>
<b>K.01.00</b>	95 98 98SE Me NT 4.0 2000	82341C ISA GPIB Interface (no Windows Me support) 82350A PCI GPIB Interface E2050A/B LAN/GPIB Gateway E2075A GPIO Interface (no Windows Me support) E1406A VXI Command Module (GPIB) E8491B VXI IEEE 1394 Slot 0 (FireWire) RS-232	<b>Added Support:</b> <ul style="list-style-type: none"> <li>• Single or dual processor support for 82350A, E2050A/B and RS-232 on Windows NT/2000</li> <li>• VISA 2.2</li> <li>• NI-488 interface cards</li> </ul> <b>No Longer Supports:</b> <ul style="list-style-type: none"> <li>• 82341D GPIB</li> </ul>

### 3 Agilent IO Libraries Description

**Table 5** Table of IO Library Revisions

IO Libraries Revision	Windows Operating Systems	Supported Interfaces	Notes
<b>J.02.00</b>	95	82341C ISA GPIB Interface	<b>Added Support:</b> <ul style="list-style-type: none"> <li>Windows 2000</li> <li>Windows Me (no support for ISA interfaces)</li> <li>VISA 1.1</li> <li>Tested 1394 Cardbus cards</li> </ul> <b>Changes:</b> <ul style="list-style-type: none"> <li>Default paths for IO Libraries have changed</li> </ul>
	98	82341D ISA GPIB Interface (Windows 95 only)	
	98SE	82350A PCI GPIB Interface	
	Me	E2050A/B LAN/GPIB Gateway	
	NT 4.0	E2075A GPIO Interface (no Windows Me support)	
	2000	E1406A VXI Command Module (GPIB) E8491B VXI IEEE 1394 Slot 0 (FireWire) RS-232	
<b>H.01.02</b>  <b>or</b>	95	82341C ISA GPIB Interface	<b>Added Support:</b> <ul style="list-style-type: none"> <li>Single or dual processor support for E8491A/B,</li> </ul>
	98	82341D ISA GPIB Interface (Windows 95 only)	
	NT 4.0	82350A PCI GPIB Interface E2050A/B LAN/GPIB Gateway	
		E2075A GPIO Interface	
<b>H.01.03</b> (ships with E985x controllers)		E1406A VXI Command Module (GPIB) E8491A/B VXI IEEE 1394 Slot 0 (FireWire) VXI Embedded Controllers RS-232	<b>No Longer Supports:</b> <ul style="list-style-type: none"> <li>Windows 3.1 and NT 3.51</li> <li>16-bit applications on Windows 95 and 98</li> </ul>
<b>G.02.02</b>	95	82341C ISA GPIB Interface	<b>Added Support:</b> <ul style="list-style-type: none"> <li>Windows 98</li> <li>Single or dual processor support for E8491A</li> </ul>
	98	82341D ISA GPIB Interface (Windows 95 only)	
	NT 3.51	82350A PCI GPIB Interface	
	NT 4.0	E2050A/B LAN/GPIB Gateway E2075A GPIO Interface	
		E1406A VXI Command Module (GPIB) E8491A VXI IEEE 1394 Slot 0 (FireWire) VXI Embedded Controllers RS-232	
<b>B.03.13</b> (available on G.02.02 CD)	3.1	82335B ISA GPIB Interface	
		82341C ISA GPIB Interface	
		E2075A GPIO Interface	
		E1406A VXI Command Module (GPIB)	
		RS-232	

\*USB instruments are those that support the USBTMC or USBTMC-USB488 specifications.



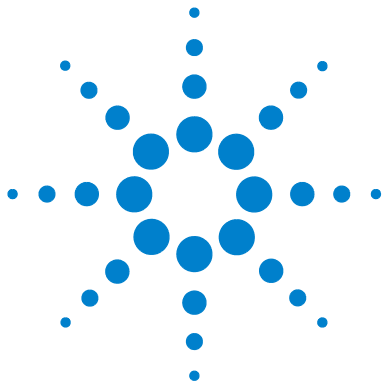

## 4 Using IO Configuration Utilities



# Using IO Configuration Utilities

This chapter provides guidelines for using Agilent IO configuration utilities to configure IO interfaces, including:

- Getting Started
- Using IO Config
- Using VISA Assistant
- Using the ViFind32 Debug Utility
- Using VXI Resource Manager
- Using the LAN Server

### NOTE

In most cases, you can open and run the IO Config utility and use the default choices for your specific interface. If you have questions about interface configuration or you want to change the interface settings, see [Chapter 5](#), “Configuring IO Interfaces.”

---

## Getting Started

Depending on the hardware interfaces in your system, you can use one or more IO utilities to configure the Agilent IO Libraries for your system. This section shows how to get started using these utilities.

### NOTE

If you have multiple operating systems on your PC, you need to install and configure the Agilent IO Libraries on each operating system to be used for IO programming.

---

Before you can use an IO interface with SICL or VISA, you must first configure the interface with the IO Config utility (located in the *Agilent IO Libraries* program folder). IO Config should be used exclusively to configure all interfaces used with SICL and VISA. To get started using the IO Configuration utilities:

- 1 Determine the IO interfaces for your system (GPIB, VXI, LAN, etc.).
- 2 As required, see the applicable section in [Chapter 5](#), “Configuring IO Interfaces” for guidelines to configuring the

interface(s). For example, see “Configuring GPIB Interfaces” for GPIB interfaces, etc.

- 3 See “Using IO Config” in this chapter for guidelines to use the IO Config utility to configure interfaces.
- 4 As needed, see “Using VISA Assistant” or “Using the VXI Resource Manager” or “Using the LAN Server” for configuration information.
- 5 See the *Agilent VISA User’s Guide for Windows* for information on VISA commands. See the *Agilent SICL User’s Guide for Windows* for details on SICL commands. After the Agilent IO Libraries are installed, these manuals are available in electronic form from the blue **IO** icon on the Windows taskbar. Click the icon and then click **View Documentation**.

## Using IO Config

This section provides guidelines for using the IO Libraries configuration utility IO Config. You can use IO Config to configure hardware interfaces (such as an 82350A GPIB card, etc.) for use with VISA and SICL on a PC with Windows 98SE/Me/2000/XP/NT.

### NOTE

Agilent recommends exiting all VISA and SICL applications before running IO Config.

## IO Config Requirements

The IO Config utility is used by the Agilent IO Libraries to configure instrument IO hardware interfaces. An interface must be configured with IO Config before the interface can be used with the IO Libraries. You can configure all available interfaces with IO Config for use with the Agilent IO Libraries. With IO Config, you can also add, edit, or remove configuration entries for the interface(s) you specify.

IO Config is an interactive program that searches your system for installed interfaces that VISA and SICL support. You select the interface(s) you want to configure and IO Config selects default parameters required to configure the interface(s).

You can run IO Config at any time. However, you must first install an interface card in your system before you can configure the interface. IO Config verifies that an interface card is installed before a configuration entry is added for the card.

You must have system administrator privileges on Windows 2000/XP/NT to run IO Config. You may also need to reboot the computer if you add or modify interfaces with IO Config to load or update driver files for specific interfaces in the Windows kernel. IO Config informs you if it is necessary to reboot your computer.

When you configure VISA with IO Config, the default configuration is to identify all VISA devices at application runtime. If you experience slow performance and/or timeouts when running VISA applications, you may want to edit the VISA configuration and uncheck the **Identify devices at runtime** box.

### Running IO Config

The purpose of IO Config is to configure an IO interface for use with VISA or SICL. IO Config does this by associating a unique VISA and/or SICL name with a hardware interface. You can use IO Config to configure new interfaces and/or edit or remove configured interfaces.

The IO Libraries use an **Interface Name** or **Logical Unit Number** to identify an interface. This information is passed in the parameter string of the **viOpen** function call in a VISA program or in the **iopen** function call in a SICL program. IO Config assigns an Interface Name and Logical Unit Number to the interface hardware, as well as other necessary configuration values for an interface when the interface is configured.

**NOTE**

Logical Unit Number is only used in SICL. It cannot be used in VISA.

**Open IO Config**

Open IO Config by double-clicking the **IO Config** icon in the *IO Libraries* program group or by clicking the Agilent IO Libraries Control icon (the blue **IO** icon on the Windows taskbar) and then selecting **Run IO Config**. The following figure shows a typical display with configured interfaces.

**Available Interface Types**  
Lists the VISA Type (ASRL, GPIB, etc.) available for configuration. To configure a new interface, highlight the interface and click **Configure**.

**Configured Interfaces**  
Lists the VISA Name and SICL Name for each configured interface.  
  
To edit a configured interface, highlight the VISA/SICL Name and click **Edit**.  
  
To remove a configured interface, highlight the VISA/SICL Name and click **Remove**.

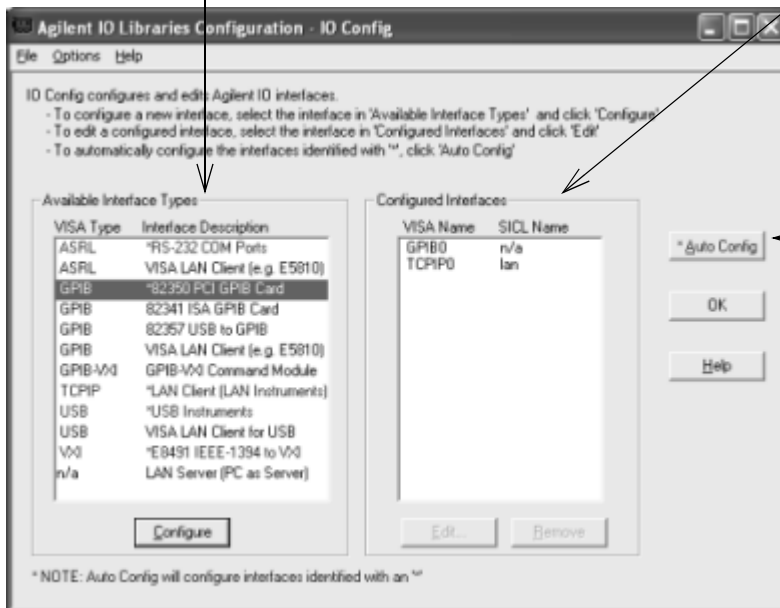

**\*Auto Config**  
Click the **Auto Config\*** button to automatically configure all interfaces marked with an asterisk (\*) to their default settings.

### Configuring a New Interface

To use IO Config to configure a new interface, highlight the interface in the **Available Interface Types** box and then click the **Configure** button. The applicable configuration screen then appears. For example, for the previous figure, since **GPIB 82350 PCI GPIB Card** is highlighted, the **82350 PCI GPIB Card Configuration** screen appears after you click the **Configure** button.



When the **82350 PCI GPIB Card Configuration** screen appears, set the **SICL Interface Name**, the **VISA Interface Name**, the **Logical Unit**, and **Bus Address** values as required, then click **OK**. If you have more than one 82350 card in your system, repeat for remaining cards. If you have questions about using IO Config for a specific interface, click the **Help** button on the IO Config dialog box.

#### NOTE

For interfaces marked with an asterisk (\*), you can click the **\*Auto Config** button to automatically configure all marked interfaces to their default values. However, you must manually configure interfaces that are not marked with an asterisk.

### Editing a Configured Interface

To edit a configured interface, highlight the line with the appropriate **VISA Name** and **SICL Name** and then click the **Edit** button to display the dialog box for the specified interface. Make the changes required on the dialog box and then click **OK** to store the changes.

In most cases, you can use the automatic defaults. However, if you need to change a value, click the arrows next to the value's field. If there are no arrows, click in the field and type in the value you want.

Note the name of the interface (such as **gpib0**, etc.), the **Logical Unit Number** of the interface for use in SICL applications, and the **Device Address** for use in VISA applications.

### Removing a Configured Interface

To remove a configured interface, highlight the line with the **VISA Name** and **SICL Name** of the interface you wish to remove, and then click **Remove**.

#### NOTE

When VISA LAN Client is configured, LAN Client is also automatically configured. Thus, two configured interfaces (such as **GPIB0** for VISA LAN Client and **TCPIP0** for LAN Client) are displayed. Do NOT delete the LAN Client entry, as the VISA LAN Client interface does not work if you do this. A single LAN Client interface can be used for any number of VISA LAN Client interfaces.

### Example: Using IO Config

An **IO interface** can be defined as both a hardware interface and a software interface. The purpose of the IO Config utility is to associate a unique interface name with a hardware interface.

For example, the GPIB interface system in the following figure consists of a Windows PC with two 82350 GPIB cards connected to three GPIB instruments via GPIB cables. For this system, IO Config was used to assign GPIB card #1 a VISA name of **GPIB0** and a SICL name of **gpib0**.

## 4 Using IO Configuration Utilities

IO Config was also used to assign GPIB card #2 a VISA name of **GPIB1** and a SICL name of **gpib1**. With these names assigned to the interfaces, the VISA/SICL addressing is as shown in the figure.

Since unique names have been assigned by IO Config, you can use the VISA **viOpen** command to open the IO paths to the GPIB instruments as shown in the figure. Or, you can use the SICL **iopen** command to open the IO paths shown.

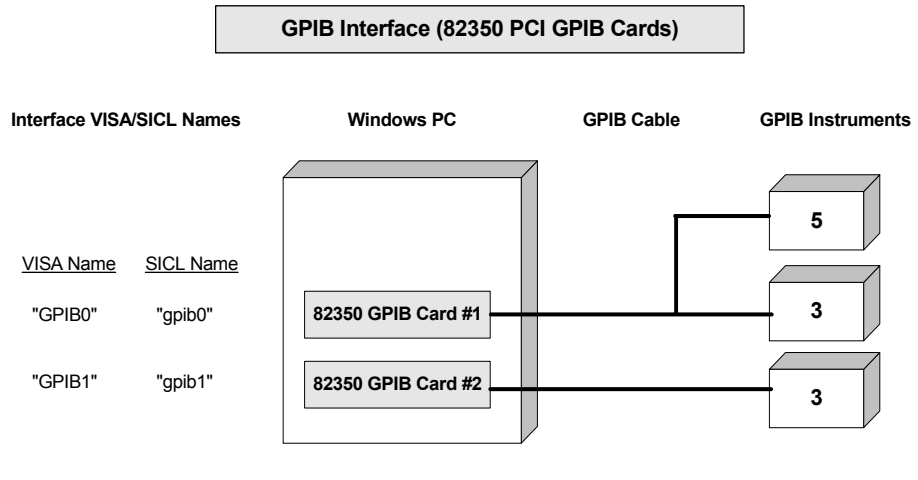

### VISA/SICL Addressing

VISA: viOpen (... "GPIB0::5::INSTR"...)    Open IO path to GPIB instrument at address 5 using 82350 Card #1
viOpen (... "GPIB0::3::INSTR"...)    Open IO path to GPIB instrument at address 3 using 82350 Card #1
viOpen (... "GPIB1::3::INSTR"...)    Open IO path to GPIB instrument at address 3 using 82350 Card #2
SICL: iopen ("gpib0, 5")    Open IO path to GPIB instrument at address 5 using 82350 Card #1
iopen ("gpib0,3")    Open IO path to GPIB instrument at address 3 using 82350 Card #1
iopen ("gpib1,3")    Open IO path to GPIB instrument at address 3 using 82350 Card #2



## Using VISA Assistant

VISA Assistant is a VISA application program that can be used to communicate with VISA “INSTR” resource class devices.

### VISA Assistant Overview

VISA Assistant can automatically detect and assign *VXIplug&play* instrument drivers to instruments. VISA Assistant can also be used to send and receive strings to instruments which support formatted IO. For other instruments, VISA Assistant allows you to read and write memory areas. VISA Assistant also describes attributes that are associated with an instrument.

### Running VISA Assistant

To run VISA Assistant, click **Start | Programs | Agilent IO Libraries | VISA Assistant** or click the Agilent IO Libraries Control **IO** icon on the taskbar, and then click **Run VISA Assistant**. A typical display showing the system Instrument View follows. For information about using VISA Assistant, click the **Help** menu button.

## 4 Using IO Configuration Utilities

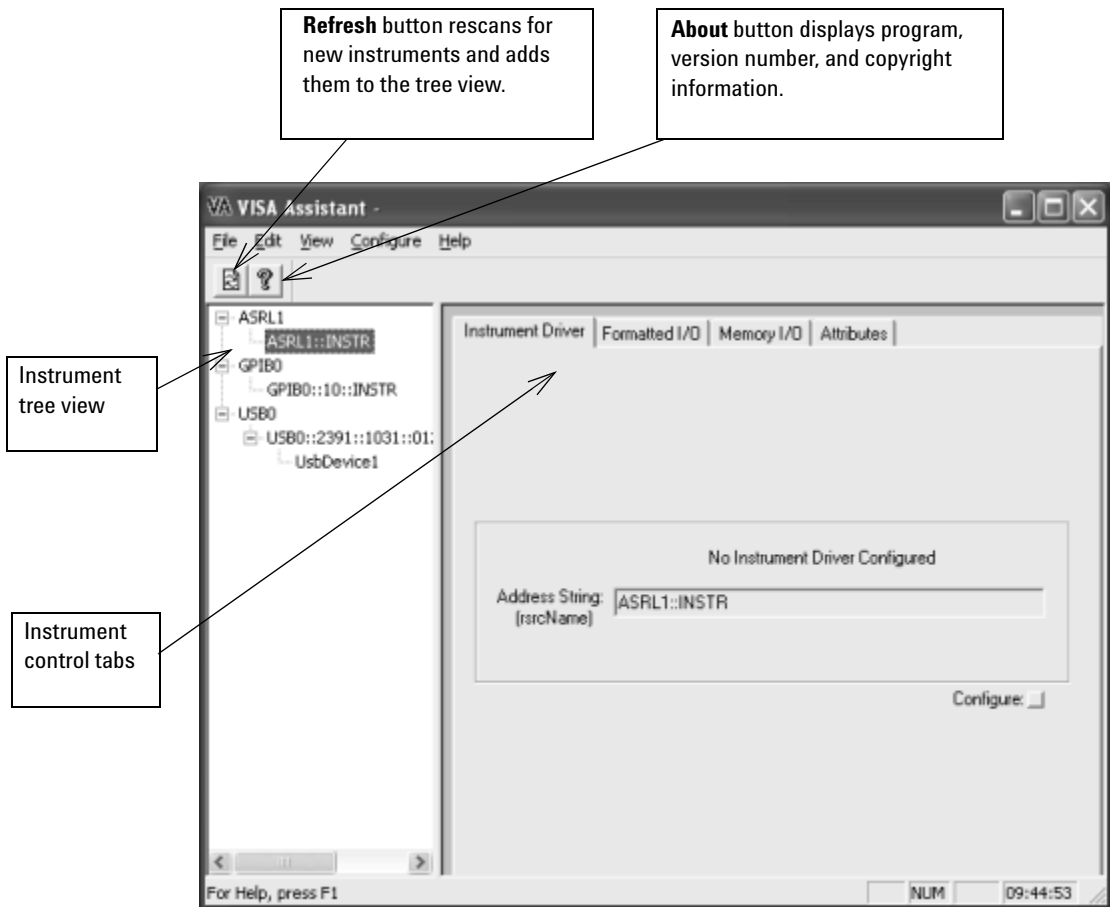

### Example: Using VISA Assistant

After the IO interface has been configured with IO Config, you can use the VISA Assistant utility to establish communication between your PC and system instruments. This example shows

one way to use VISA Assistant for communication between your PC and GPIB instruments. To use VISA Assistant for communication:

- 1 Click the blue **IO** icon on the Windows taskbar.
- 2 Click **Run VISA Assistant** to display the main screen.
- 3 Highlight the instrument to be addressed.
- 4 Select the **Formatted I/O** tab.
- 5 Select the **IEEE 488-2** button.
- 6 Click the **\*IDN?** button.
- 7 The instrument identification string appears.

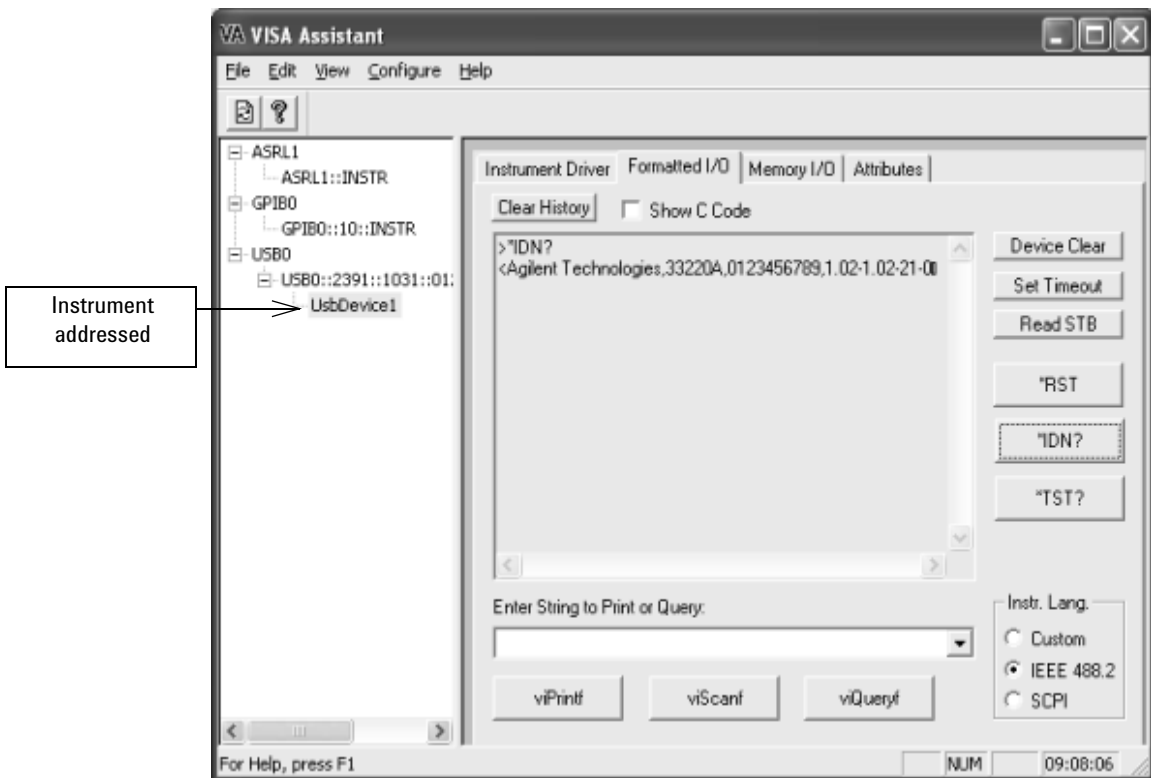

### NOTE

In the Instrument tree view above, the USB instrument has been assigned an alias name so both the full VISA resource string and alias name are shown. You can select either the VISA full resource string or the alias name to communicate with the USB instrument.

---

## Using the ViFind32 Debug Utility

ViFind32 is a debug utility that lists all VISA resources found.

### ViFind32 Overview

ViFind32 is a console application that uses the *viFindRsrc* / *viFindNext* VISA functions to enumerate all resources visible to VISA. This application is useful for verifying that all expected interfaces are configured with IO Config and that the expected devices have been attached.

### Running ViFind32

To run the ViFind32 debugging utility, click **Start | Programs | Agilent IO Libraries | ViFind32** or click the Agilent IO Libraries Control **IO** icon on the taskbar, and then click **Run ViFind32**. The console window will appear with the list of VISA devices. When you press the **Enter** key, the ViFind32 will exit and the console window will close.

ViFind32 does not actually communicate with a device; therefore, devices which are manually configured in VISA may appear in the list even though they are not actually present.

Following is an example of the ViFind32 output in a console window.

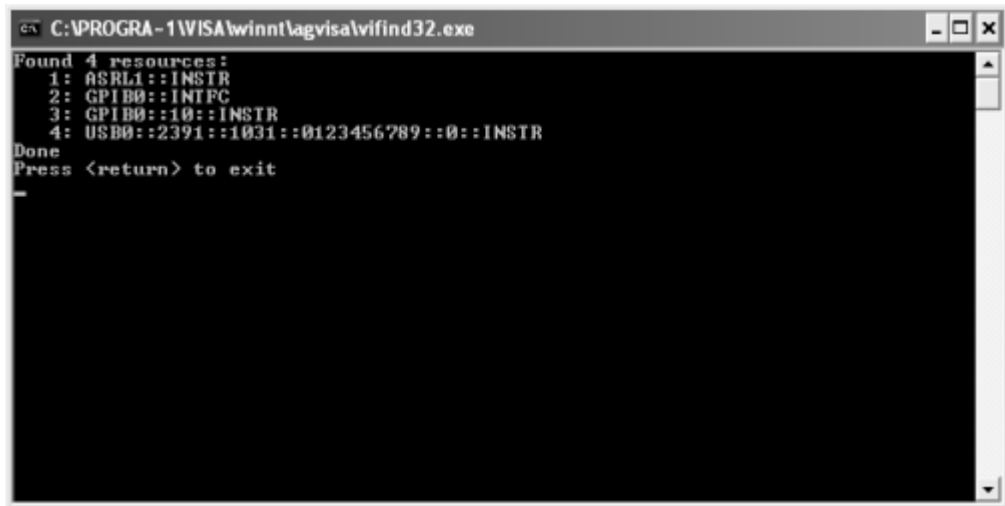

```

C:\PROGRA-1\WISA\winnt\agvisalvifind32.exe
Found 4 resources:
1: ASRL1::INSTR
2: GPIB0::INTFC
3: GPIB0::10::INSTR
4: USB0::2391::1031::0123456789::0::INSTR
Done
Press <return> to exit

```

**NOTE**

ViFind32 displays only the full VISA resource string, and does not show device alias names.

You can also run ViFind32 from an open console window. When run in this manner, you may specify different command line options:

```
Usage: vifind32 [-hnxop] [expression]
```

Where:

- h = Print this Help screen.
- n = Print number of matches only
- x = Keep calling viFindNext until failure
- o = Open each resource and get information about it
- p = Pause when done (debugging)

You may not specify both -n and -x.

expression -- Regular expression to use. If not specified,

then use ?\*

Here are some command line options examples:

```
ViFind32 -oopen each resource as it is found and print information about it
```

```
ViFind32 ?*INSTRfind only VISA INSTR resources
```

```
ViFind32 -n USB?*print the number USB resources
```

### Using the VXI Resource Manager

If your system includes an E8491 IEEE-1394 PC Link to VXI interface, you can view the output of the VXI Resource Manager to determine if your system is properly configured.

#### VXI Resource Manager Overview

The VXI Resource Manager initializes and prepares the VXI system for use. The VXI Resource Manager runs when:

- VXI mainframe power is applied or cycled
- The E8491 Reset button is pressed
- It is activated from Agilent IO Libraries Control **IO** icon
- The computer is rebooted

In VXI systems with multiple E8491s, individual mainframes can be turned off without affecting other mainframes in the system. When a mainframe is turned on, the Resource Manager reconfigures the mainframe.

**NOTE**

The Agilent IO Libraries Control utility must be running to enable the VXI Resource Manager to run. The VXI Resource Manager is installed when the E8491 interface is configured using IO Config. Click the blue **IO** icon on the taskbar to access the IO Libraries Control utility.

If the IO Libraries Control icon is not visible, you can display the icon by clicking **Start | Programs | Agilent IO Libraries | IO Control**. The displays in this section are from Windows 2000. Displays for Windows 98SE/Me/XP/NT may be slightly different.

---

### Displaying VXI Resource Manager Output

If an E8491 has previously been installed and configured with IO Config, the VXI Resource Manager automatically runs every time Windows starts. If you change the E8491 configuration in IO Config, the VXI Resource Manager runs automatically (after a 5 second delay) when IO Config is closed.

After the VXI Resource Manager has run, you can view its output. To display the **Resource Manager** screen, click the Agilent IO Libraries Control **IO** icon on the taskbar and click **Edit VXI Resource Manager**. The following figure is a typical display.

## 4 Using IO Configuration Utilities

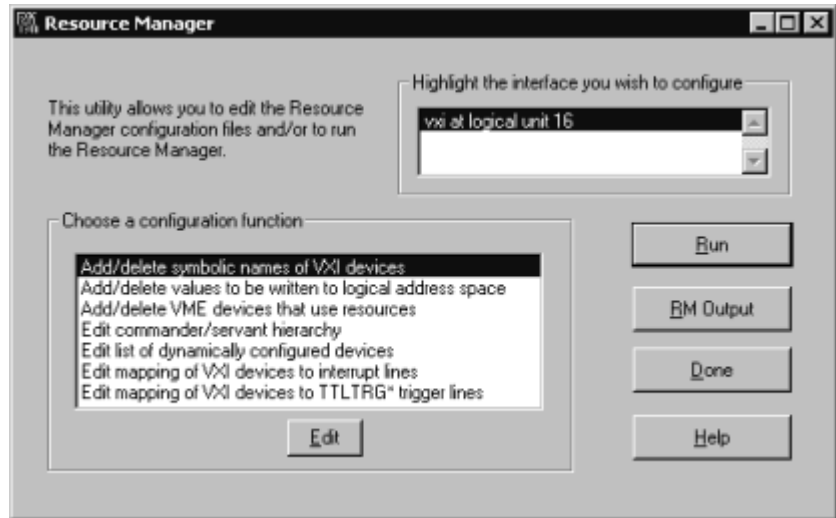

To view the system configuration (the VXI Resource Manager output), click **RM Output**. The following figure shows a part of a typical display.

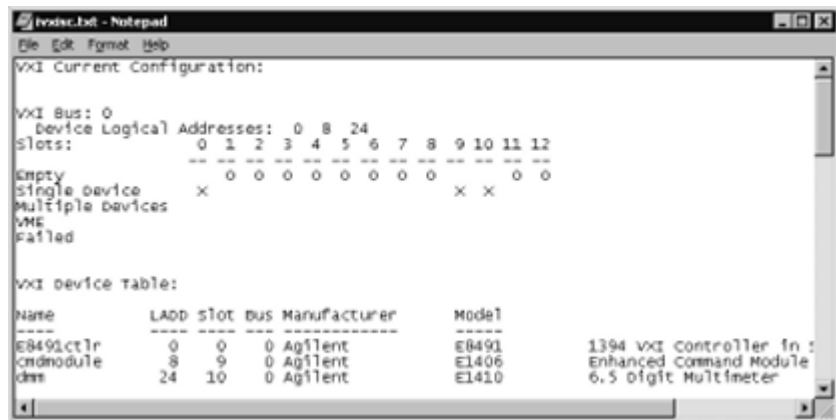



## Using the LAN Server

If you configured the LAN server on this system using IO Config, you must now start the LAN server process on this system.

### Starting the LAN Server

- The LAN server starts automatically when Windows boots for Windows 9X systems only. On 2000, XP, and NT, you must start the LAN server manually or create a shortcut to the LAN server in the **Start | Programs | Startup** folder for the LAN server to start on boot-up.
- To start the LAN server, you can *either* restart (reboot) the system now or manually start the LAN server process on the system.
- To manually start the LAN server process on the system after the LAN server has been configured using IO Config, click the **LAN Server** icon in the *Agilent IO Libraries* program group.

The LAN server is now running. You can minimize the **LAN Server** window so that the LAN Server process is listed on the Windows taskbar.

### Stopping the LAN Server

To stop the LAN server process from running on the system:

- 1 Open the **LAN Server** window on the screen and move the cursor into the **LAN Server** window.
- 2 Type `Ctrl+C` to close the window. The LAN server process is stopped.

## **4 Using IO Configuration Utilities**



## 5 Configuring IO Interfaces



# Configuring IO Interfaces

This chapter provides guidelines for configuring and addressing IO interfaces, including:

- Configuring GPIB Interfaces
- Configuring VXI Interfaces
- Configuring USB Interfaces
- Configuring LAN Interfaces
- Configuring ASRL Interfaces

### NOTE

See [Chapter 4](#), “Using IO Configuration Utilities” for information on using IO Configuration utilities (IO Config, VISA Assistant, VXI Resource Manager, and LAN Server). See the *Agilent VISA User’s Guide for Windows* for details on VISA commands. See the *Agilent SICL User’s Guide for Windows* for details on SICL commands.

When the Agilent IO Libraries are installed, an electronic version of each document is available by clicking the blue **IO** icon on the taskbar and selecting **View Documentation**.

---

## Introduction to IO Interface Configuration

An **IO interface** can be defined as both a hardware interface and a software interface. The purpose of the IO Config utility is to associate a unique software interface name with a hardware interface.

The IO Libraries use an **Interface Name** or **Logical Unit Number** to identify an interface. This information is passed in the parameter string of the **viOpen** function call in a VISA program or in the **iopen** function call in a SICL program. IO Config assigns an Interface Name and Logical Unit Number to the interface hardware, as well as other necessary configuration values for an interface when the interface is configured.

When the IO interface is configured, you can use Agilent VISA or Agilent SICL to program assigned instruments. For example, the following figure shows the VISA and SICL addressing for GPIB instruments connected to a PC via a GPIB interface.

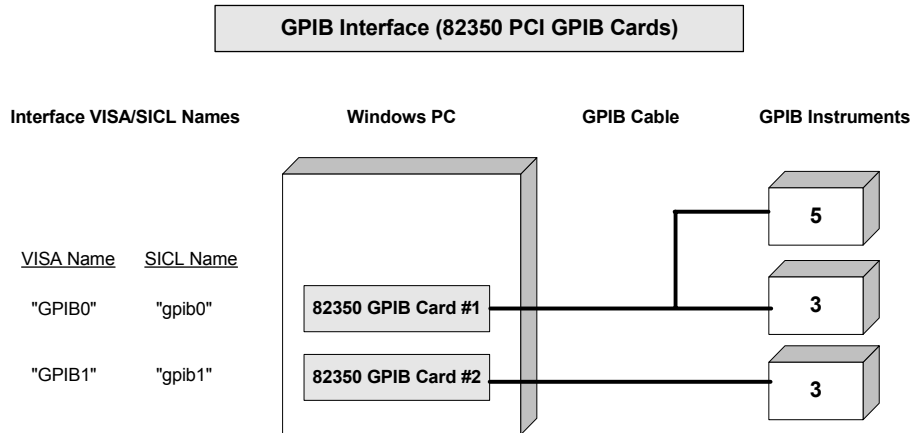

**VISA/SICL Addressing**

VISA: viOpen (... "GPIB0::5::INSTR"...) viOpen (... "GPIB0::3::INSTR"...) viOpen (... "GPIB1::3::INSTR"...)	Open IO path to GPIB instrument at address 5 using 82350 Card #1 Open IO path to GPIB instrument at address 3 using 82350 Card #1 Open IO path to GPIB instrument at address 3 using 82350 Card #2
SICL: iopen ("gpib0, 5") iopen ("gpib0,3") iopen ("gpib1,3")	Open IO path to GPIB instrument at address 5 using 82350 Card #1 Open IO path to GPIB instrument at address 3 using 82350 Card #1 Open IO path to GPIB instrument at address 3 using 82350 Card #2

**Configuring GPIB Interfaces**

This section provides guidelines for using the IO Config utility to configure GPIB interfaces, including:

- GPIB Interfaces Overview
- Configuring GPIB (82357 USB) Interfaces
- Configuring GPIB (82350 PCI) Interfaces
- Configuring GPIB (82341 ISA) Interfaces

### GPIB Interfaces Overview

A GPIB interface connects a Windows PC to one or more GPIB instruments. There are three types of GPIB interfaces: USB, PCI, and ISA.

#### NOTE

A fourth type of GPIB interface is the **GPIB VISA LAN Client** (e.g., 5810). This interface is described in “Configuring LAN Interfaces” in this chapter.

---

- **USB Interfaces:** For USB interfaces, IO communication is via a USB port installed in the PC, a USB cable, and a USB/GPIB interface (such as the 82357 USB/GPIB Gateway).
- **PCI Interfaces:** For PCI interfaces, IO communication is via a PCI GPIB card (such as an 82350) installed in the PC and GPIB cables.
- **ISA Interfaces:** For ISA interfaces, IO communication is via an ISA GPIB card (such as an 82341) installed in the PC and GPIB cables.

The following figure shows typical GPIB interfaces to GPIB instruments at addresses 3 and 5.

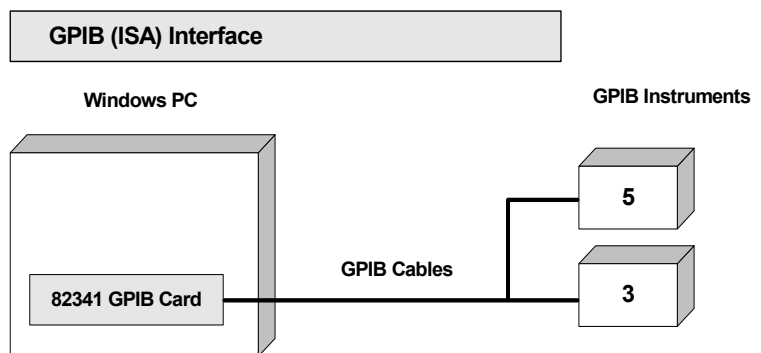
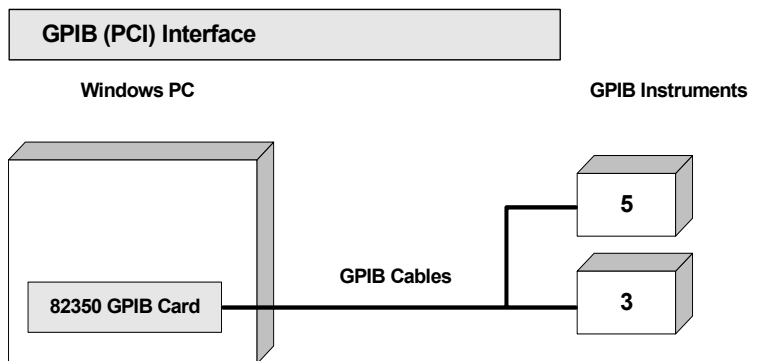
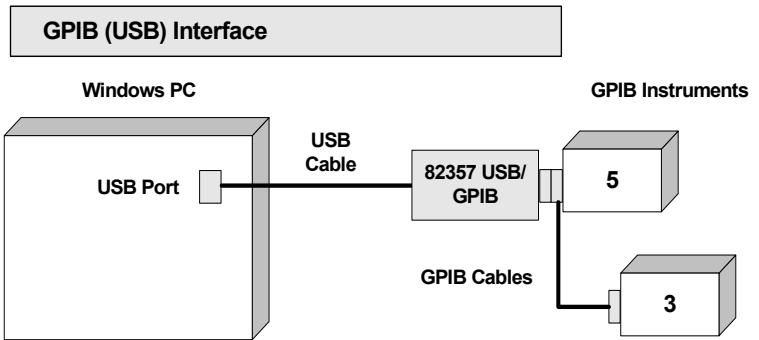

### Configuring GPIB (82357 USB) Interfaces

**NOTE**

An 82357 is automatically configured when the USB connector is plugged into the PC. You can use the steps in this section to modify an existing configuration.

**Using IO Config to Configure GPIB (82357 USB) Interfaces** To configure 82357 USB/GPIB interfaces using IO Config:

- 1 Click the Agilent IO Libraries Control **IO** icon (blue icon on the Windows taskbar) and click **Run IO Config**. When the main screen appears, highlight the **GPIB 82357 USB to GPIB** menu item and then click the **Configure** button.

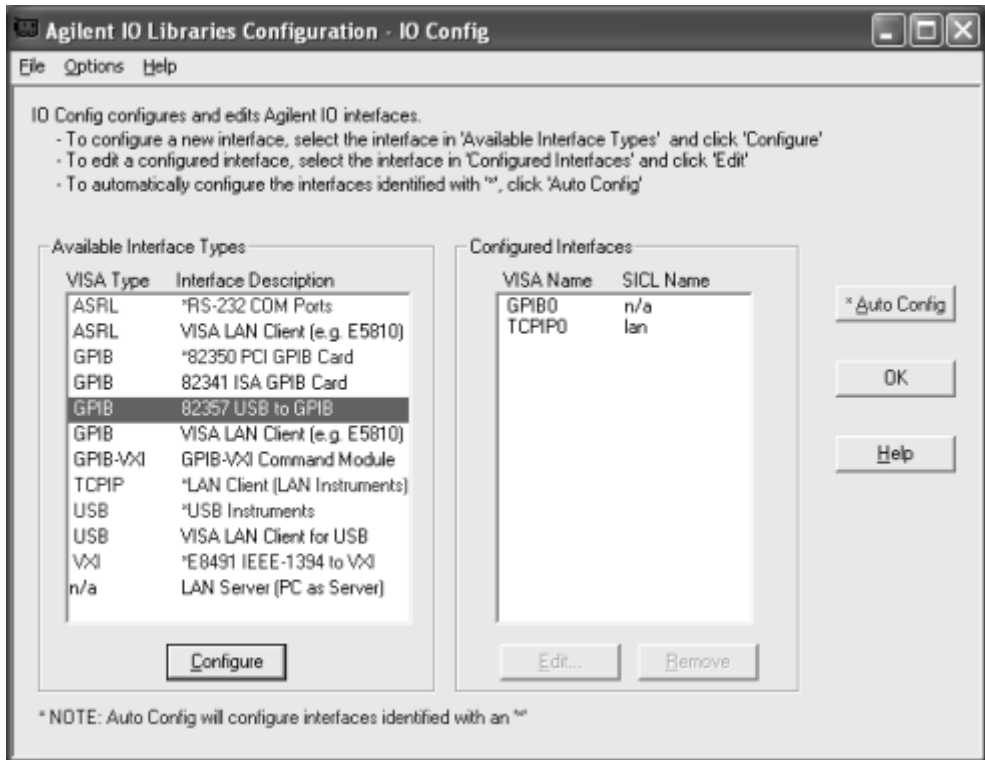



- 2 If more than one 82357 is installed in your system, the **Select Interface to Configure** screen may appear. If this screen appears, select the **Serial Number** of the interface you want to configure and then click **OK** to display the **82357 USB to GPIB Configuration** screen.
- 3 When the **82357 USB to GPIB Configuration** screen appears, set the **VISA Interface Name**, the **SICL Interface Name**, the **Logical Unit** and **Bus Address** values as required. Then, click the **OK** button.
- 4 If you have more than one 82357 in your system, repeat for remaining interfaces.

**NOTE**

After the system is configured, this screen may also display an **Edit VISA Config...** button. Clicking this button allows you to manually configure the interface as desired.

**Example: Configuring GPIB (82357 USB/GPIB) Interface**

The GPIB interface system in the following figure consists of a Windows PC with an 82357 USB/GPIB Interface connected between a USB port and three GPIB instruments. The instruments are connected via GPIB cables.

For this system, the IO Config utility has been used to assign a VISA name of **GPIB1** and a SICL name of **gpib1**. With these names assigned to the interfaces, the VISA/SICL addressing is as shown in the figure.

Since unique names have been assigned by IO Config, you can use the VISA **viOpen** command to open the IO paths to the GPIB instruments as shown in the above figure. Or, you can use the SICL **iopen** command to open the IO paths shown.

## 5 Configuring IO Interfaces

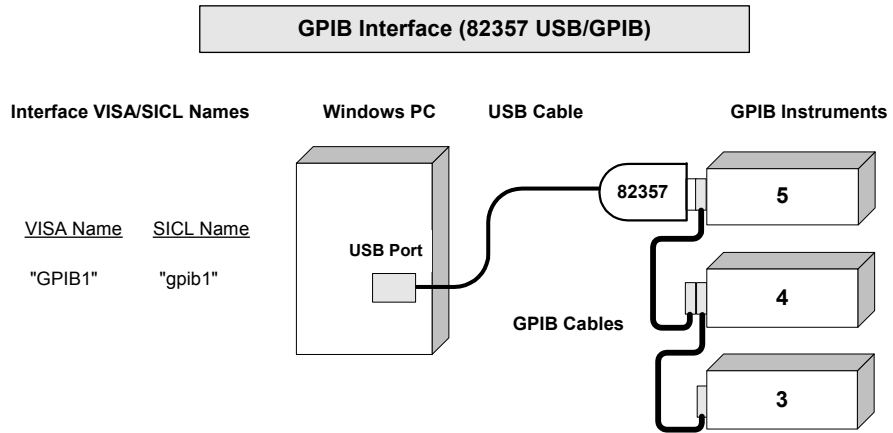

### VISA/SICL Addressing

VISA: viOpen (... "GPIB1::5::INSTR"...)	Open IO path to GPIB instrument at address 5 using 82357
viOpen (... "GPIB1::4::INSTR"...)	Open IO path to GPIB instrument at address 4 using 82357
viOpen (... "GPIB1::3::INSTR"...)	Open IO path to GPIB instrument at address 3 using 82357
SICL: iopen ("gpib1,5")	Open IO path to GPIB instrument at address 5 using 82357
iopen ("gpib1,4")	Open IO path to GPIB instrument at address 4 using 82357
iopen ("gpib1,3")	Open IO path to GPIB instrument at address 3 using 82357

## Configuring GPIB (82350 PCI) Interfaces

**Using IO Config to Configure GPIB (82350 PCI) Interfaces** To configure GPIB (82350 PCI) interfaces using IO Config:

- 1 Click the Agilent IO Libraries Control **IO** icon (blue icon on the Windows taskbar) and click **Run IO Config**. When the main

screen appears, highlight the **GPIB 82350 PCI GPIB Card** menu item and then click the **Configure** button.

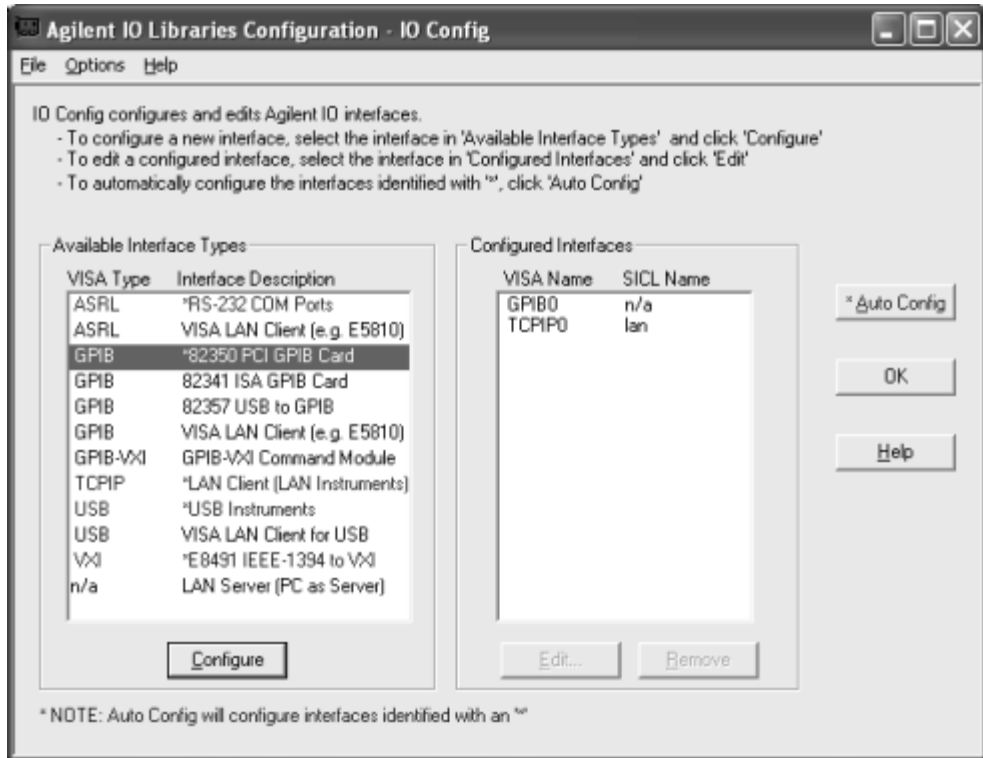

- 2 When the **82350 PCI GPIB Card Configuration** screen appears, set the **VISA Interface Name**, **SICL Interface Name**, **Logical Unit** and **Bus Address** values as required. Then, click the **OK** button.
- 3 If you have more than one 82350 card in your system, repeat for remaining cards.

#### NOTE

After the system is configured, this screen may also display an **Edit VISA Config...** button. Clicking this button allows you to manually configure the interface as desired.

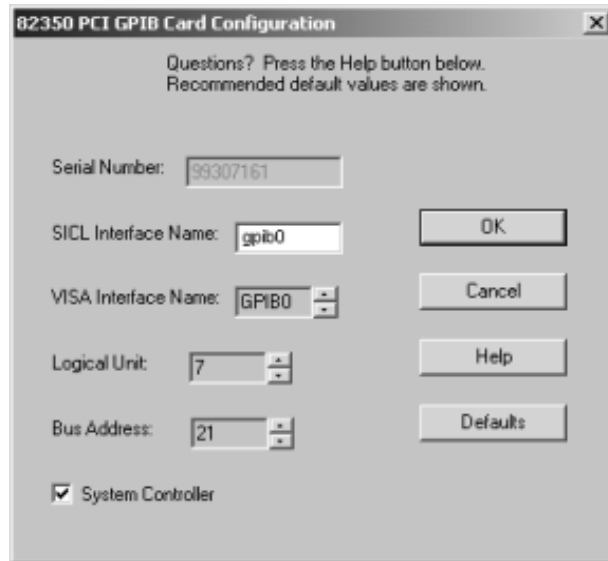

### Example: Configuring GPIB (82350 PCI) Interfaces

The GPIB interface system in the following figure consists of a Windows PC with two 82350 GPIB cards connected to three GPIB instruments via GPIB cables. For this system, the IO Config utility has been used to assign GPIB card #1 a VISA name of **GPIB0** and a SICL name of **gpib0**.

IO Config has also been used to assign GPIB card #2 a VISA name of **GPIB1** and a SICL name of **gpib1**. With these names assigned to the interfaces, the VISA/SICL addressing is as shown in the figure.

Since unique names have been assigned by IO Config, you can use the VISA **viOpen** command to open the IO paths to the GPIB instruments as shown in the figure. Or, you can use the SICL **iopen** command to open the IO paths shown.

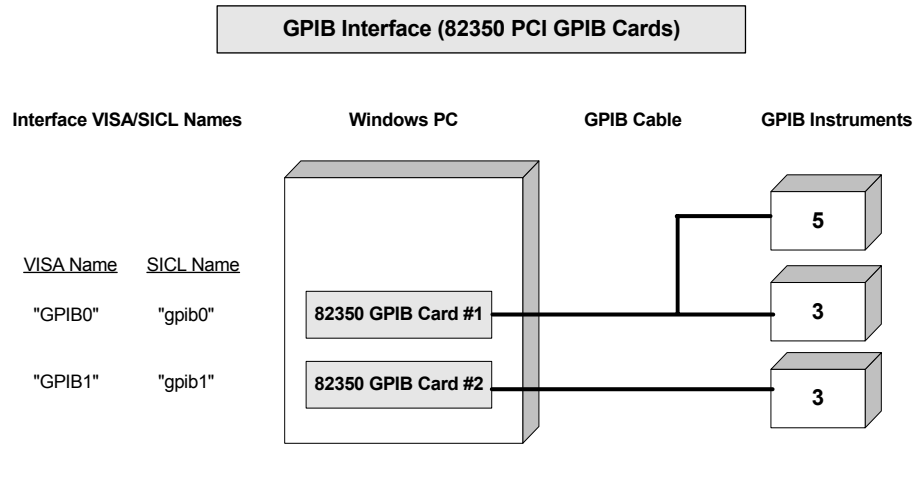

**VISA/SICL Addressing**

VISA: viOpen (... "GPIB0::5::INSTR"...) viOpen (... "GPIB0::3::INSTR"...) viOpen (... "GPIB1::3::INSTR"...)  SICL: iopen ("gpib0, 5") iopen ("gpib0,3") iopen ("gpib1,3")	Open IO path to GPIB instrument at address 5 using 82350 Card #1 Open IO path to GPIB instrument at address 3 using 82350 Card #1 Open IO path to GPIB instrument at address 3 using 82350 Card #2  Open IO path to GPIB instrument at address 5 using 82350 Card #1 Open IO path to GPIB instrument at address 3 using 82350 Card #1 Open IO path to GPIB instrument at address 3 using 82350 Card #2
---	--

**Configuring GPIB (82341 ISA) Interfaces**

**Using IO Config to Configure GPIB (82341 ISA) Interfaces** To configure GPIB (82341 ISA) interfaces using IO Config:

- 1 Click the Agilent IO Libraries Control **IO** icon (blue icon on the Windows taskbar) and then click **Run IO Config**. When the

main screen appears, highlight the **GPIB 82341 ISA GPIB Card** menu item and then click the **Configure** button.

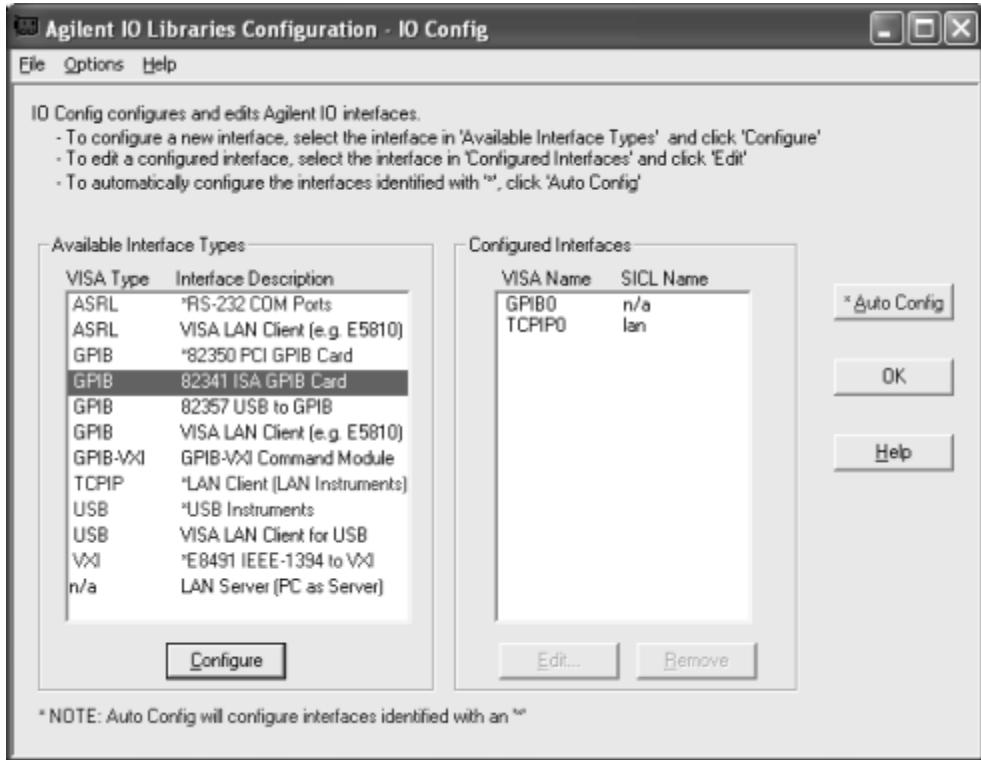

- When the **82341 ISA GPIB Card Configuration** screen appears, set the **VISA Interface Name**, **SICL Interface Name**, and the **Logical Unit**, **IRQ Line**, and **Bus Address** values as required. Then, click the **OK** button.
- If you have more than one 82341 card in your system, repeat for the remaining cards.

### NOTE

After the system is configured, this screen may also display an **Edit VISA Config...** button. Clicking this button allows you to manually configure the interface as desired.

**Example: Configuring GPIB ISA (82341) Interfaces**

The GPIB interface system in the following figure consists of a Windows PC with two 82341 GPIB cards connected to three GPIB instruments via GPIB cables. For this system, the IO Config utility has been used to assign GPIB card #1 a VISA name of **GPIB0** and a SICL name of **gpib0**.

IO Config has also been used to assign GPIB card #2 a VISA name of **GPIB1** and a SICL name of **gpib1**. With these names assigned to the interfaces, the VISA/SICL addressing is as shown in the figure.

Since unique names have been assigned by IO Config, you can use the VISA **viOpen** command to open the IO paths to the GPIB instruments as shown in the above figure. Or, you can use the SICL **iopen** command to open the IO paths shown.

## 5 Configuring IO Interfaces

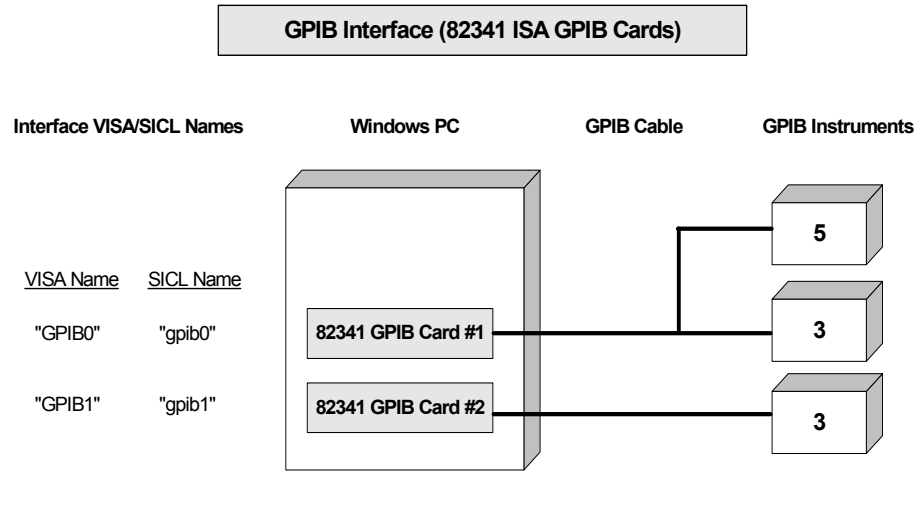

### VISA/SICL Addressing

VISA: viOpen (... "GPIB0::5::INSTR"...)	Open IO path to GPIB instrument at address 5 using 82341 Card #1
viOpen (... "GPIB0::3::INSTR"...)	Open IO path to GPIB instrument at address 3 using 82341 Card #1
viOpen (... "GPIB1::3::INSTR"...)	Open IO path to GPIB instrument at address 3 using 82341 Card #2
SICL: iopen ("gpib0,5")	Open IO path to GPIB instrument at address 5 using 82341 Card #1
iopen ("gpib0,3")	Open IO path to GPIB instrument at address 3 using 82341 Card #1
iopen ("gpib1,3")	Open IO path to GPIB instrument at address 3 using 82341 Card #2

## Configuring VXI Interfaces

This section provides guidelines to using the IO Config utility to configure VXI interfaces, including:

- VXI Interfaces Overview
- Configuring GPIB-VXI (E1406A) Interfaces
- Configuring VXI (E8491B) Interfaces



### VXI Interfaces Overview

As shown in the following figure, a typical VXI interface consists of one of two main hardware configurations: E1406A Command Module or E8491B IEEE-1394 to VXI Module.

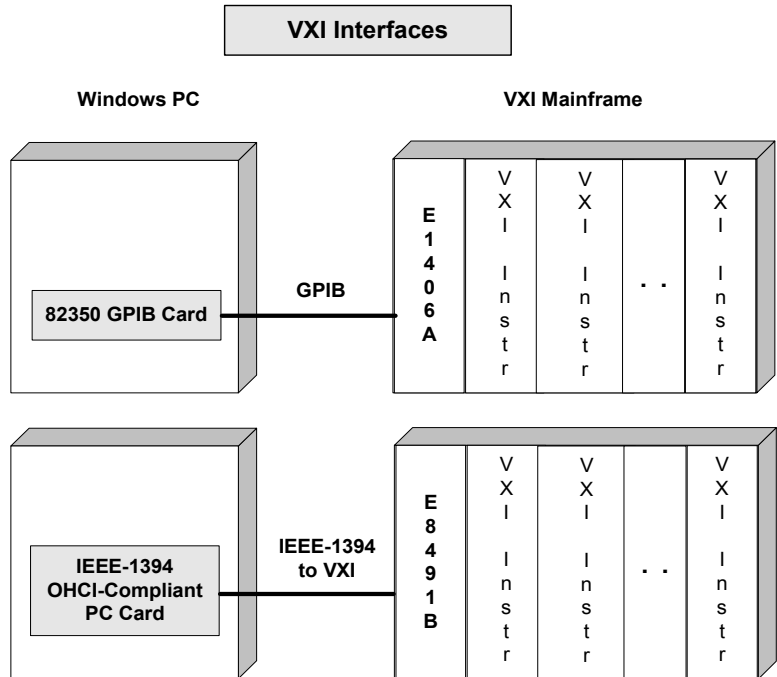

- The **E1406A Command Module** version consists of a Windows PC with an 82350 (or equivalent) GPIB card and a VXI mainframe with an E1406A Command Module and one or more VXI instruments. IO communication from the PC to the VXI instruments is via the GPIB card, GPIB cable, and E1406A Command Module.

- The **E8491B Module** version consists of a Windows PC with an IEEE-1394 OHCI-Compliant (FireWire) PC card and a VXI mainframe with an E8491B IEEE-1394 to VXI Module and one or more VXI instruments. IO communication from the PC to the VXI instruments is via the PC card, IEEE-1394 to VXI cable, and E8491B Module.

### Configuring GPIB-VXI (E1406A) Interfaces

**Using IO Config to Configure GPIB-VXI (E1406A) Interfaces** To configure GPIB-VXI (E1406A Command Module) interfaces using the IO Config utility:

- 1 Click the Agilent IO Libraries Control **IO** icon (blue icon on the Windows taskbar) and click **Run IO Config**. When the main screen appears, highlight the **GPIB-VXI Command Module** menu item and then click the **Configure** button.

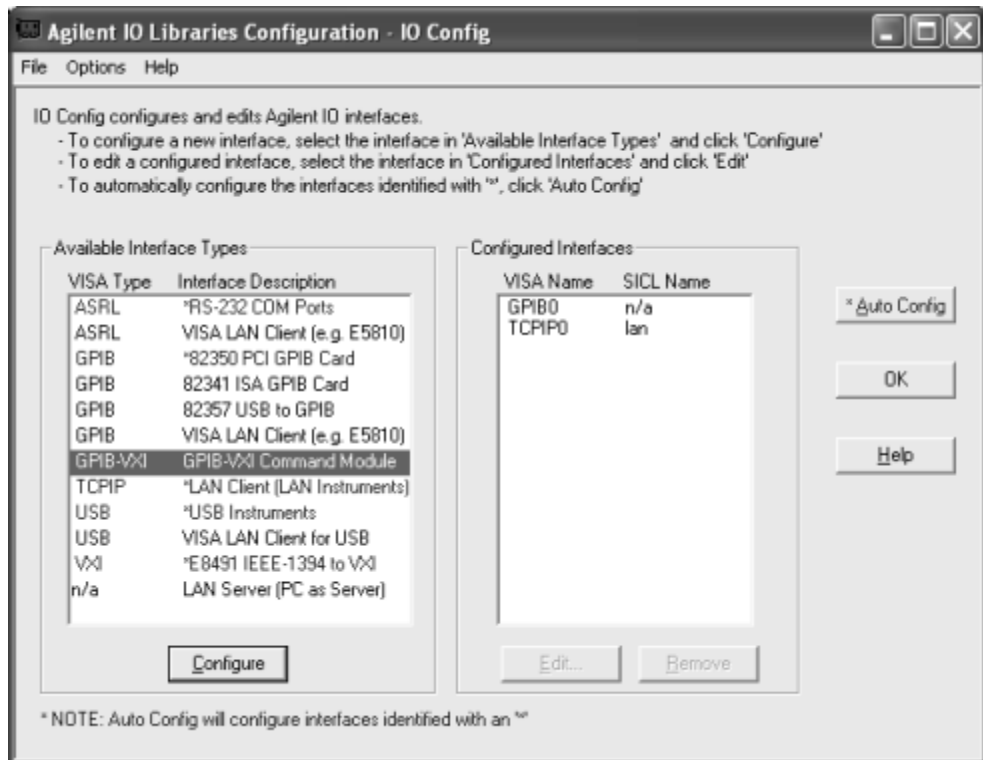

- When the **GPIB-VXI Command Module Configuration** screen appears, set the **VISA Interface Name**, **GPIB Interface Name**, and **GPIB Primary Address** as required. Then, click **OK**.

#### NOTE

After the system is configured, this screen may also display an **Edit VISA Config...** button. Clicking this button allows you to manually configure the interface as desired.

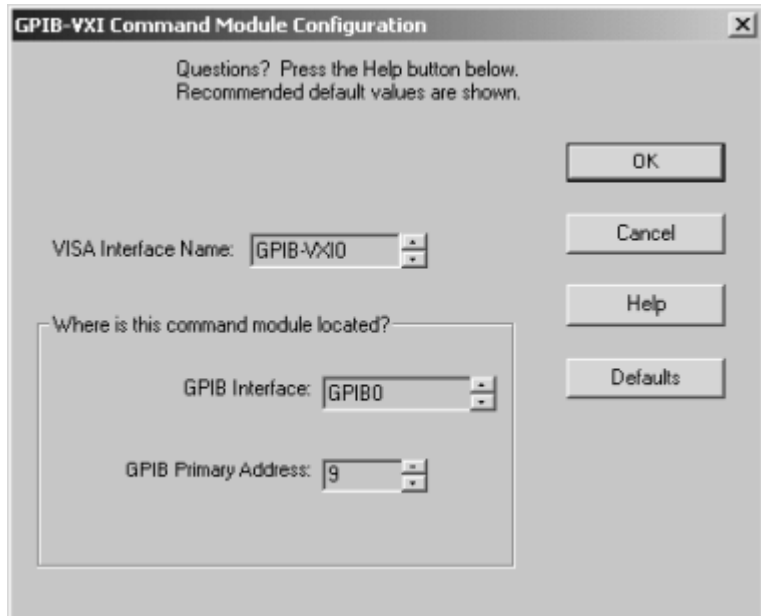

### Example: Configuring GPIB-VXI (E1406A) Interfaces

The GPIB-VXI interface system in the following figure consists of a Windows PC with an 82350 GPIB card that connects to an E1406A Command Module in a VXI Mainframe. The VXI mainframe includes one or more VXI instruments.

When the IO Libraries were installed, a GPIB-VXI driver with GPIB address 9 was also installed and the E1406A was configured for primary address 9 and logical address (LA) 0. The three VXI instruments shown have logical addresses 8, 16, and 24.

The IO Config utility has been used to assign the GPIB-VXI driver a VISA Name of **GPIB-VXI0** and to assign the 82350 GPIB card a VISA name of **GPIB0** and SICL name of **gpib0**. With these names assigned to the interfaces, the VISA addressing is as shown in the figure.

For information on the E1406A Command Module, see the *Agilent E1406A Command Module User's Guide*. For information on VXI instruments, see the applicable *VXI Instrument User's Guide*.

**GPIB-VXI Interface (E1406A Command Module)**

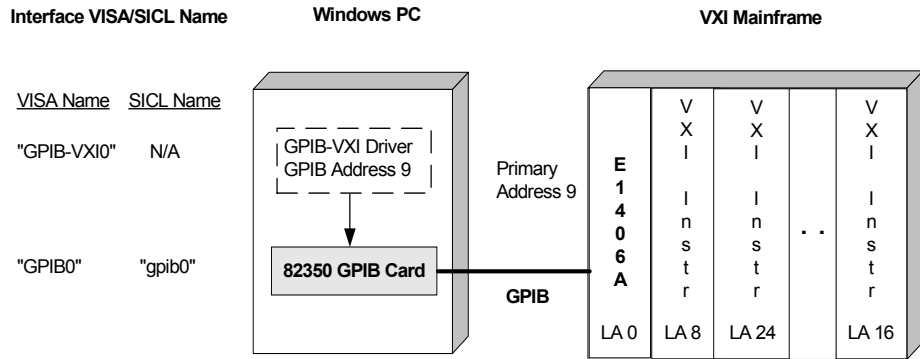

**VISA Addressing**

viOpen (... "GPIB-VXI0::24::INSTR"...)    Open IO path to VXI instrument at logical address 24 using 82350 GPIB Card and E1406A VXI Command Module at GPIB primary address 9

**Configuring VXI (E8491B) Interfaces**

**Using IO Config to Configure VXI (E8491B) Interfaces** To configure VXI (E8491B module) interfaces using the IO Config utility:

- 1 Click the Agilent IO Libraries Control **IO** icon (blue icon on the Windows taskbar) and click **Run IO Config**. When the main

## 5 Configuring IO Interfaces

screen appears, highlight the **VXI E8491 IEEE-1394 to VXI** menu item and click the **Configure** button.

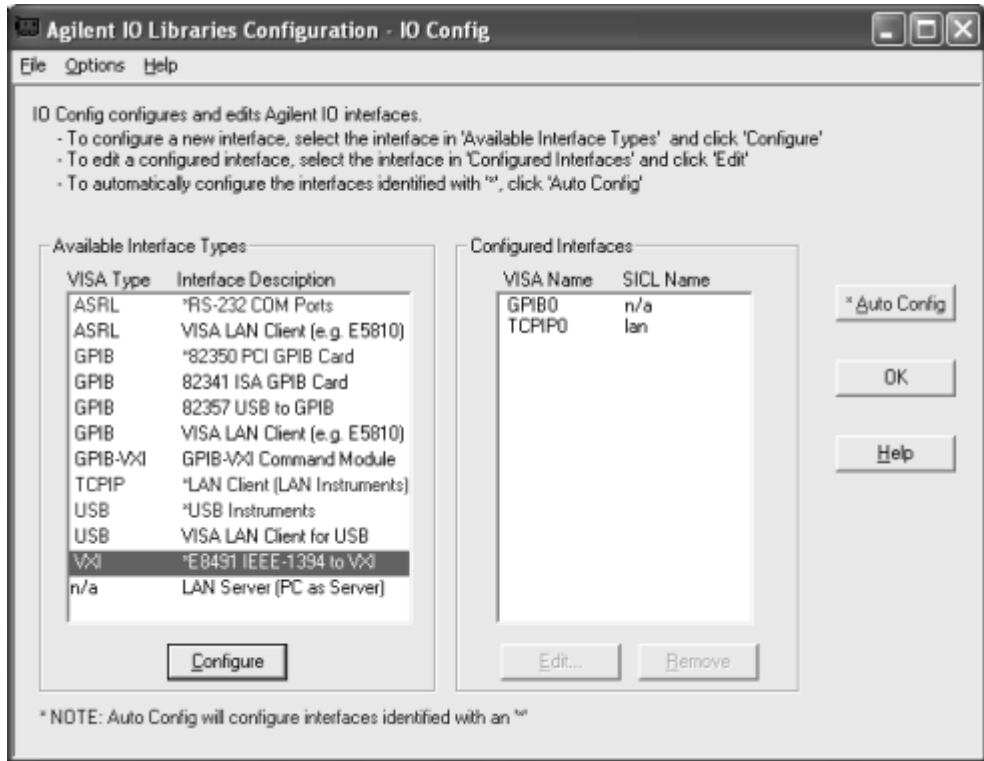

2 When the **E8491 VXI Board Configuration** screen appears, set the **VISA Interface Name**, as required. Then click **OK**.

### NOTE

After the system is configured, this screen may also display an **Edit VISA Config...** button. Clicking this button allows you to manually configure the interface as desired.

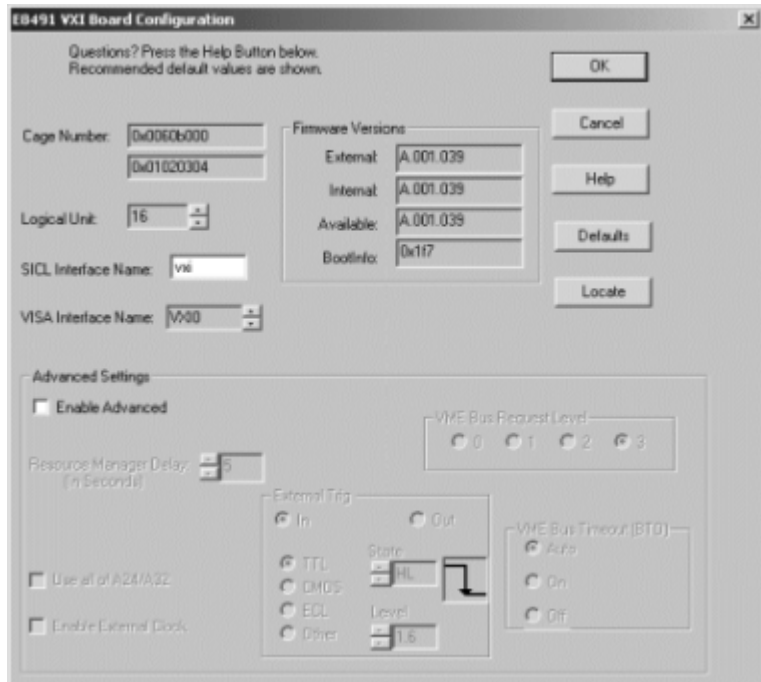

### Example: Configuring VXI (E8491B) Interfaces

The VXI interface system in the following figure consists of a Windows PC with an E8491 PC card that connects to an E8491B IEEE-1394 to VXI Module in a VXI Mainframe. The VXI mainframe includes one or more VXI instruments. For this system, the three VXI instruments shown have logical addresses 8, 16, and 24.

The IO Config utility has been used to assign the E8491 PC card a VISA name of **VXI0** and SICL name of **vxi**. With these names assigned to the interface, you can use the VISA/SICL addressing shown in the figure.

For information on the E8491B module, see the *Agilent E8491B User's Guide*. For information on VXI instruments, see the applicable *VXI Instrument User's Guide*.

## 5 Configuring IO Interfaces

### VXI Interface (E18491B IEEE-1394 to VXI Module)

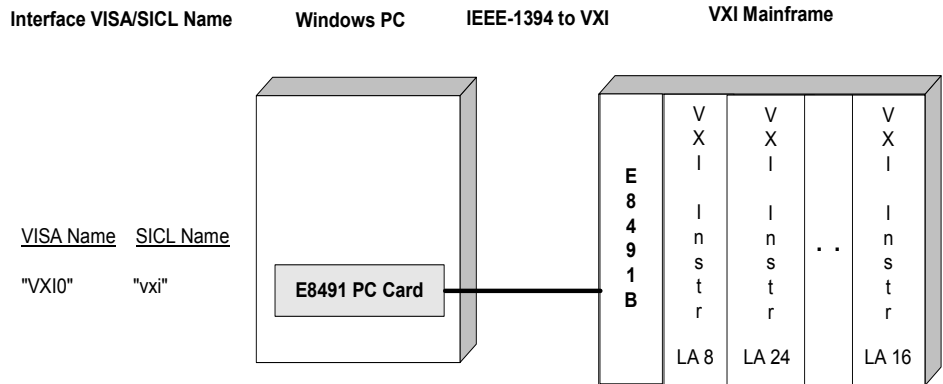

#### VISA/SICL Addressing

VISA: viOpen (... "VXI0::24::INSTR" ...)

Open IO path to VXI instrument at logical address 24 using E8491 PC Card and E8491 IEEE-1394 to VXI Module

SICL: iopen ("vxi,24")

Open IO path to VXI instrument at logical address 24 using E8491 PC Card and E8491 IEEE-1394 to VXI Module



## Configuring USB Interfaces

This section provides guidelines on how USB instruments are configured in the Agilent IO Libraries, including:

- USB Interface Overview
- Automatic Configuration of USB devices
- Editing USB device alias names with IO Config
- Troubleshooting USB device configurations

### USB interface Overview

When a USB device that implements the USBTMC or USBTMC-USB488 protocol is plugged into the computer, it will automatically be detected by the Agilent IO Libraries. It is important to note that only USBTMC and USBTMC-USB488 devices are recognized by the IO Libraries. Other USB devices such as printers, scanners, storage devices, etc. are not recognized and cannot be programmed with IO Libraries.

#### NOTE

Do not confuse the Agilent 82357 USB/GPIB Interface with a USBTMC device. The 82357 is automatically configured as a GPIB interface, not as a USBTMC device, when it is plugged into the computer. Only USBTMC/USBTMC-USB488 devices are configured as USB devices by Agilent VISA.

---

“USB instruments” in the remainder of this document refers to devices that implement the USBTMC or USBTMC-USB488 protocol.

### Automatic Configuration of USB Devices

When a USB instrument is plugged into the PC, the IO Libraries displays a configuration screen.



This screen notifies you that a USB instrument has been connected.

Due to the complexity of the VISA and SICL USB resource string, a default "alias" name is assigned to the USB instrument. You can change this alias name to one of your own choosing if you desire before clicking **OK**.

When opening a VISA resource (with the **viOpen** function) or SICL resource (with the **iopen** function), you can use either the **Preferred** alias name or the **Alternate** full string as shown on the screen when opening a resource. Using the alias name is recommended because it is simpler and allows substitution of USB instruments by simply changing the alias name rather than modifying your IO program.

Alias names can be up to 127 characters long and can consist of any combination of spaces and printable ASCII characters. Although the case of an alias name is preserved when it is

defined, case is ignored when the alias is used in a **viOpen** or an **iopen** call. For example, `UsbDevice1`, `usbdevice1` and `USBDEVICE1` all refer to the same device.

The **Assign USB device alias** screen will appear each time a USB device is connected, even if the same USB device has been connected previously. The same alias name that was in effect for the device the last time it was connected will be used by default on subsequent connections.

### Editing USB Device Alias Names with IO Config

It is not necessary to configure a USB interface with IO Config since it is done automatically when the first USB instrument is plugged into the computer. All USB instruments use the same USB interface. IO Config, can, however, be used to view and edit the alias names for all USB instruments that are attached to the computer.

- 1 To edit an alias name with IO Config, click the Agilent IO Libraries Control icon (**IO** icon on the Windows taskbar) and click **Run IO Config**. When the main screen appears, highlight the **USB0** entry in the **Configured Interfaces** box and then click **Edit**.

## 5 Configuring IO Interfaces

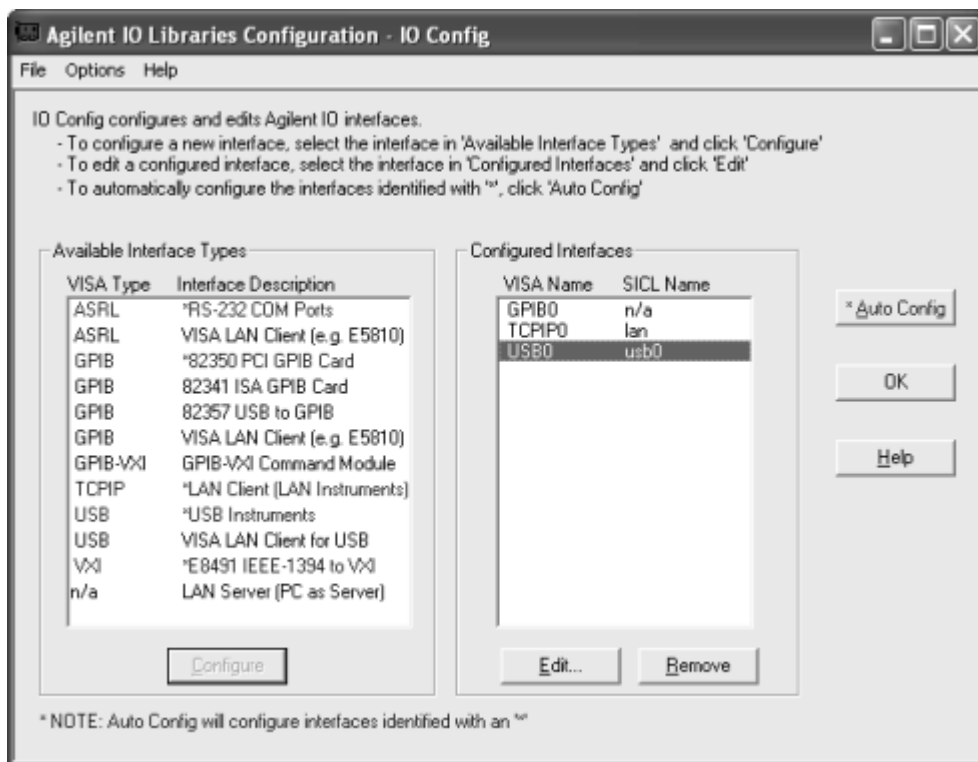

- 2 When the **USB Devices** screen appears, select the row in the table you wish to use and then add, edit, or delete an alias name for a USB device.

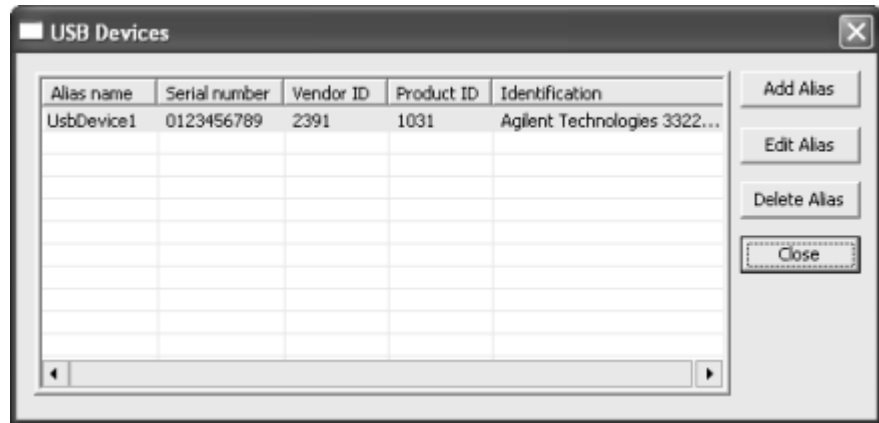

- 3 Clicking **Add Alias** presents a screen that will let you create an additional alias name for the device selected. A device can have as many alias names as you like. Notice that a default alias name is generated by adding a digit to the end of the alias name in the line that was selected.

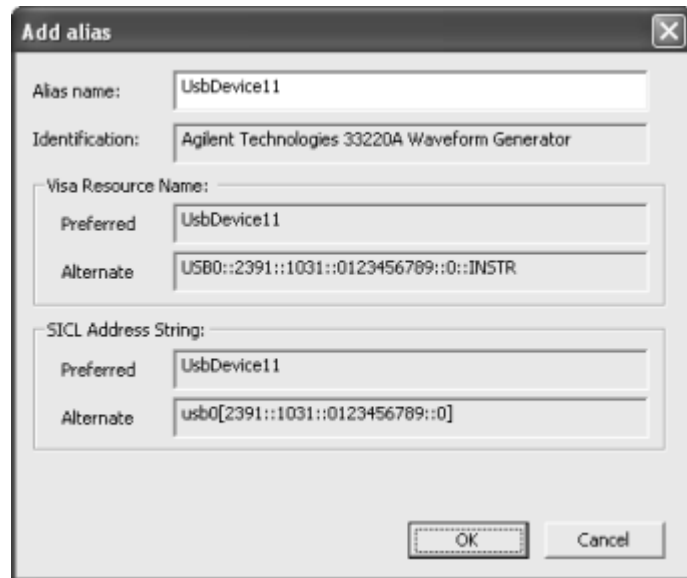

- 4 Clicking **Edit Alias** presents a screen that allows you to change the alias name for the device in the line you have selected.

The screenshot shows a dialog box titled "Edit alias" with a close button in the top right corner. The dialog contains the following fields:

- Alias name:** UsbDevice1
- Identification:** Agilent Technologies 33220A Waveform Generator
- Visa Resource Name:**
  - Preferred: UsbDevice1
  - Alternate: USB0::2391::1031::0123456789::0::INSTR
- SICL Address String:**
  - Preferred: UsbDevice1
  - Alternate: usb0[2391::1031::0123456789::0]

At the bottom right of the dialog are two buttons: "OK" and "Cancel".

- 5 Clicking **Delete Alias** deletes the selected line in the USB devices table. Note that if you accidentally delete the only alias for a USB device, it will disappear from the table and there is no way within IO Config to add back an alias for that device. If this happens, you should exit IO Config and then unplug and reconnect the device. This will pop up the **Assign USB device alias** screen, where you can assign a new alias to the device.
- 6 If IO Config is running when you plug a USB device in, you will not be able to create an alias name for it. If this happens, follow the instructions on the screen.



### Troubleshooting USB Device Configurations

The information in this section is the latest available at the time of publication. Since this information is subject to continuous change, be sure to check the *Instrument I/O | IO Libraries Troubleshooting* section of the Agilent Developer Network (ADN) Knowledge Library at

<http://www.agilent.com/find/adnknowledge>

for the most up-to-date information.

### USB Hardware Successfully Tested with Agilent's USB-equipped Products

During development of Agilent's new USB-equipped products, Agilent has validated that various USB hardware products work well with these USB-equipped products. This section describes these USB hardware products and what is needed to use them effectively.

### NOTE

Please note that the USB 1.1 and USB 2.0 ports ONLY work properly on Windows XP when the latest Microsoft USB drivers from Windows XP's Service Pack 1 have been properly installed. Since this installation does not automatically occur upon upgrading Windows XP to Service Pack 1, Agilent has developed a guide on how to examine and install these drivers if needed. See the "Ensuring Windows XP SP1 USB Drivers are Installed" section in this document for details. In addition, only USB 1.1 is supported on any Windows operating system other than Windows XP SP1 (that is, on Windows 2000, Windows Me, and Windows 98SE). Also note that efforts are underway to ensure that Windows 2000 can reliably support a USB 2.0 connection to Agilent products, but that this effort may not succeed. Check for a new version of the IO Libraries and associated documents at

<http://www.agilent.com/find/adniolib>

for notification and an upgrade if and when this Windows 2000 qualification effort is completed.

---

**Tested USB 1.1 Host Controller Port Hardware** Agilent has discovered no issues with most USB 1.1 host controller port hardware. Note that the latest USB drivers must be installed from Service Pack 1 for Windows XP for reliable USB 1.1 operation (see the Note box above for details). For other operating systems (Windows 2000, Windows ME, and Windows 98SE), make sure you have installed the latest USB drivers available for your port hardware (check the vendor's website for details). In addition, Agilent recommends using the latest service pack for Windows 2000 (which is SP3 at the time of this writing).

Of course, it has not been feasible for Agilent to test with all port hardware available anywhere at any time, so if your application encounters issues that you suspect are related to the USB 1.1 port hardware, try a different vendor's hardware (either by adding a different add-on card, or the built-in USB 1.1 port hardware on a different computer).



An up-to-date list of successfully tested host controller port hardware and USB hub hardware is located in the *Instrument I/O | IO Libraries Troubleshooting* section of the Agilent Developer Network (ADN) Knowledge Library at:

<http://www.agilent.com/find/adnknowledge>

**Tested USB 2.0 Host Controller Port Hardware** Agilent's experience with USB 2.0 host controller port hardware was somewhat different than that with USB 1.1 port hardware -- more host controller port hardware was found to have significant problems that could not be resolved.

Again, an up-to-date list of successfully tested host controller port hardware and USB hub hardware is located in the *Instrument I/O | IO Libraries Troubleshooting* section of the Agilent Developer Network (ADN) Knowledge Library at:

<http://www.agilent.com/find/adnknowledge>

### **Ensuring Windows XP SP1 USB Drivers are Installed**

Agilent's new USB connectivity to instruments requires that the latest Microsoft USB drivers for Windows XP be installed properly with Service Pack 1. If your computer already has USB drivers installed (either built-in or added via a plug-in USB card), Service Pack 1 will not always upgrade these existing drivers. The following sections provide information on how to validate that the correct drivers are installed and how to install them if they are not installed. This procedure assumes that you have already successfully installed Service Pack 1 on your Windows XP computer.

### **Validating Installation of the Latest USB Drivers**

To validate that you have the correct drivers, click **Start | Settings | Control Panel | System** to open the **System Properties** dialog window. Click the **Hardware** tab, then the **Device Manager** button to view the devices in your system. Near the bottom of the list, you should see a node in the list titled "Universal Serial Bus controllers." Click the "+" sign to the left of "Universal Serial Bus controllers" to see the list of USB controllers and hubs (the USB "devices") on your computer.

Note that USB ports on your computer show up as multiple devices in **Device Manager**, and that both USB 1.1 port devices (if any) and USB 2.0 port devices are shown together in this list.

Agilent recommends most (but not all) USB 2.0 add-on cards that are based on the NEC USB 2.0 host controller chip. As for built-in USB 2.0 ports (that is, where the USB 2.0 host controller chip is on the motherboard of the computer), Agilent recommends the Intel USB 2.0 host controller chip. At this writing, Agilent has found only a few issues with USB 1.1 add-on cards or built-in USB 1.1 host controller chips as long as you have the latest Microsoft drivers installed. See the “USB Hardware Successfully Tested with Agilent’s USB-equipped Products” section for details on the host controllers that were successfully tested by Agilent.

In the **Device Manager** list, you should see corresponding NEC Open Host Controllers and/or Intel Universal Host Controllers, along with NEC and/or Intel Enhanced Host Controllers.

For each Controller or Hub in the **Device Manager** list (starting from the top and proceeding to the bottom), right-click the item to open its **Properties** page. Do this even for Controllers or Hubs that do not indicate they are manufactured by NEC or Intel. Click the **Driver** tab, then the **Driver Details** button to view the **Driver File Details** for the drivers that are installed for that device. Ensure that each Controller or Hub in the following table has **5.1.2600.1106** or higher for the **File Version** of the corresponding driver:

**Table 1**

Name of USB device	Must be present with File Version 5.1.2600.1106 or higher	Must be File Version 5.1.2600.1106 or higher IF PRESENT		
NEC or Intel Enhanced Host Controller	usbehci.sys	hccoin.dll	usbhub.sys	usbport.sys

Table 1

Name of USB device	Must be present with File Version 5.1.2600.1106 or higher	Must be File Version 5.1.2600.1106 or higher IF PRESENT	
Intel Universal Host Controller	usbuhci.sys	usbhub.sys	usbport.sys
NEC Open Host Controller	usbohci.sys	usbhub.sys	usbport.sys
USB Root Hub or USB 2.0 Hub or Generic USB Hub		usbhub.sys	usbport.sys

You may observe driver files other than those in this table; do not be concerned about their versions, as they do not necessarily need to be at 5.1.2600.1106 or higher (the File Version you see for them is most likely the latest version that is available for them).

If you encounter any USB host controller or hub device in **Device Manager** that does NOT have the corresponding required Microsoft driver, or if the driver file is in the above table but does not have **File Version 5.1.2600.1106** or higher, *this device must have its drivers updated*. Use the following procedure to update each USB host controller or hub device that needs to be updated.

### Updating USB drivers

Right-click the device that must have its drivers updated, and click the **Driver** tab in the **Properties** page that appears. Click the **Update Driver** button to start the **Hardware Update Wizard**. Follow the procedure provided by this wizard, using the defaults provided. In most every case, this should update your driver files to their latest versions from Microsoft. When you have updated all the devices that require new drivers, follow the

procedure in the previous section entitled “Validating Installation of the Latest USB Drivers” to ensure that this update procedure has been successful.

If any devices still need to have their drivers updated at this point, right-click each of them in **Device Manager** and click **Uninstall**. You may be prompted to reboot your system - in any case, reboot your system when you have uninstalled all the devices that still require updated drivers. After your system reboots, it should discover these "new devices" (those you have just uninstalled) and if the **Add New Hardware Wizard** starts, it will guide you through the process of installing the Microsoft drivers (the system may install the new drivers automatically without the use of the wizard). By following the defaults provided in this wizard, you should successfully install the "new" USB devices with the latest Microsoft drivers. You should validate this (again following the steps in the previous section entitled “Validating Installation of the Latest USB Drivers”).

If you still do not have the required drivers, contact the manufacturer of your USB port hardware for assistance in installing the latest Microsoft USB drivers for their hardware.

### Configuring LAN Interfaces

This section provides guidelines to using the IO Config utility to configure LAN interfaces, including:

- LAN Interfaces Overview
- Configuring TCP/IP LAN Client Interfaces
- Configuring GPIB VISA LAN Client Interfaces
- Configuring ASRL VISA LAN Client Interfaces
- Configuring LAN Server Interfaces

#### LAN Interfaces Overview

This section provides guidelines for using the Agilent IO Libraries to configure instruments over a Local Area Network (LAN). A LAN is a way to extend the control of instrumentation

beyond the limits of typical instrument interfaces. To communicate over the LAN, you must first configure the TCP/IP LAN Client interface.

**NOTE**

When GPIB VISA LAN Client (e.g. E5810) or ASRL VISA LAN Client (e.g. E5810) is configured, TCP/IP LAN Client (LAN Instruments) is also automatically configured.

### LAN Client/Server Model

The LAN software provided with the Agilent IO Libraries allows instrumentation control over a LAN. Using standard LAN connections, instruments can be controlled from computers that do not have special interfaces for instrument control.

The LAN software uses the **client/server model** of computing. **Client/server computing** refers to a model where an application (the **client**) does not perform all necessary tasks of the application itself. Instead, the client makes requests of another computing device (the **server**) for certain services.

### LAN Hardware Architecture

As shown in the following figure, a LAN client (such as a Windows 98SE/Me/2000/XP/NT PC) makes VISA requests over the network to a LAN server (such as a Windows 98SE/Me/2000/XP/NT PC or an E5810 LAN/GPIB Gateway for Windows).

The LAN server is connected to the instrumentation or devices to be controlled. Once the LAN server has completed the requested operation on the instrument or device, the LAN server sends a reply to the LAN client. This reply contains requested data and status information that indicates whether or not the operation was successful.

The LAN server acts as a **gateway** between the LAN software that the client system supports and the instrument-specific interface that the device supports.

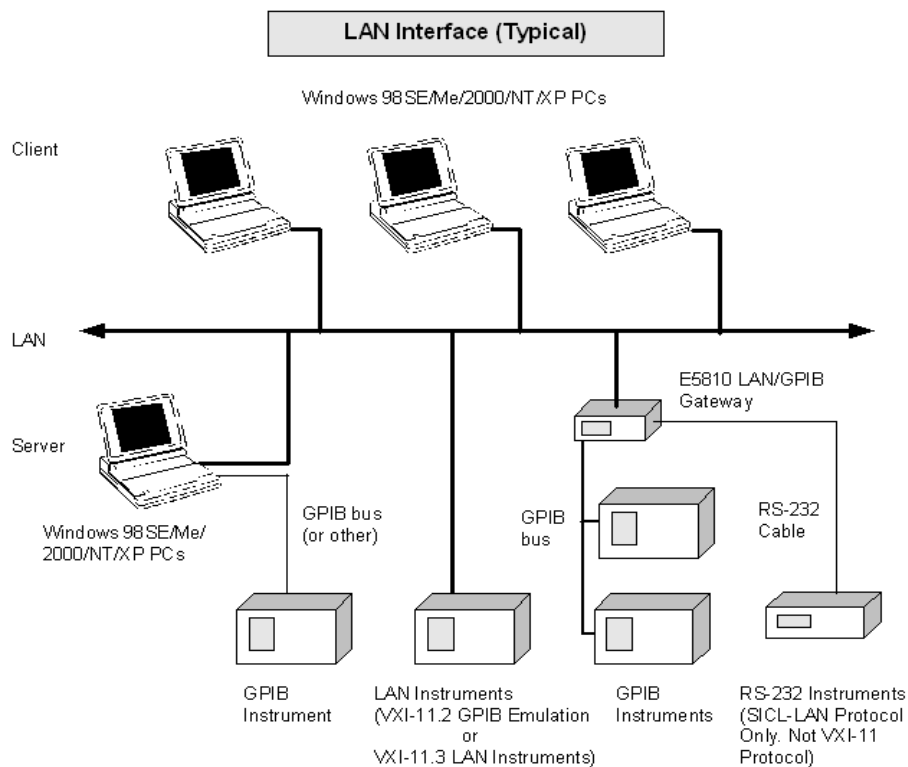

### LAN Software Architecture

As shown in the following figure, the client system contains the LAN client software and the LAN software (TCP/IP) needed to access the server (gateway). The gateway contains the LAN server software, LAN (TCP/IP) software, and the instrument driver software needed to communicate with the client and to control the instruments or devices connected to the gateway.

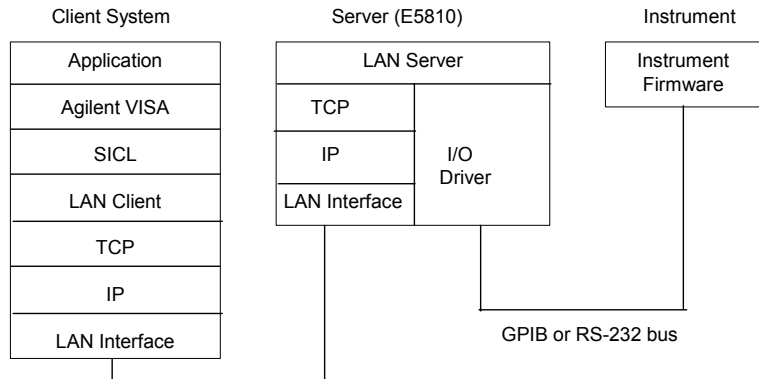

The LAN software is built on top of standard LAN networking protocols. There are two LAN networking protocols provided with the Agilent IO Libraries software. You can use one or both of these protocols when configuring your systems (via Agilent IO Libraries configuration) to use VISA and SICL over LAN.

- **SICL-LAN Protocol** is a networking protocol developed by Agilent that is compatible with all VISA LAN products. This LAN networking protocol is the default choice in the Agilent IO Libraries configuration when configuring the LAN client. The SICL LAN protocol on HP-UX 10.20 and on Windows 98SE/Me/2000/XP/NT supports VISA operations over LAN to GPIB interfaces.
- **VXI-11 (TCP/IP Instrument Protocol)** is a networking protocol developed by the VXIbus Consortium based on the SICL LAN Protocol that permits interoperability of LAN software from different vendors who meet the VXIbus Consortium standards.

When using either of these networking protocols, the LAN software uses the TCP/IP protocol suite to pass messages between the LAN client and the LAN server. The server accepts device IO requests over the network from the client and then proceeds to execute those IO requests on a local interface (GPIB, etc.).

By default, the LAN Client supports both protocols by automatically detecting the protocol the server is using. When a VISA **viOpen** or SICL **iopen** call is performed, the LAN Client driver first tries to connect using the SICL-LAN protocol. If that fails, the driver tries to connect using the VXI-11 protocol.

If you want to control the protocol used, you can configure more than one LAN Client interface and set each interface to a different protocol. The protocol used depends upon the interface you are connecting through.

In VISA, the protocol used is determined by the configuration settings and cannot be changed programatically. In SICL, the programmer can override the configuration settings by specifying the protocol in the **iopen** string. Some examples follow. Note that SICL names are case-sensitive.

- **iopen("lan[machineName]:gpib0,1")** uses the configured default protocol. If AUTO is configured, SICL-LAN protocol is attempted. If that is not supported, VXI-11 protocol is used.
- **iopen("lan;auto[machineName]:gpib0,1")** automatically selects the protocol (SICL-LAN if available and VXI-11 otherwise.)
- **iopen("lan;sicl-lan[machineName]:gpib0,1")** uses SICL-LAN protocol.
- **iopen("lan;vxi-11[machineName]:gpib0,1")** uses VXI-11 protocol.

The LAN Client also supports TCP/IP socket reads and writes.

To open a socket session, use

```
iopen( "lan,socketNbr[machineName] " ). For example,  
iopen( "lan,7777[machineName] " ) opens a socket  
connection for socket number 7777 on 'machineName'.
```

When you have configured VISA LAN Client interfaces, you can then use the interface name specified during configuration in a VISA **viOpen** call of your program.



## Configuring TCP/IP LAN Client Interfaces

### NOTE

When GPIB VISA LAN Client (e.g. E5810) or ASRL VISA LAN Client (e.g. E5810) is configured, TCP/IP LAN Client (LAN Instruments) is also automatically configured.

A single TCP/IP Lan Client interface can be used by any number of VISA LAN Client interfaces. The main reason for having more than one LAN Client configured is if you want to use different protocols (such as SICL-LAN or VXI-11) in different VISA LAN Clients.

---

**Using IO Config to Configure TCP/IP LAN Client Interfaces** To configure TCP/IP LAN Client interfaces using the IO Config utility:

- 1 Click the Agilent IO Libraries Control icon (blue **IO** icon on the Windows taskbar) and click **Run IO Config**. When the main screen appears, highlight the **TCPIP LAN Client (LAN Instruments)** menu item and then click the **Configure** button.

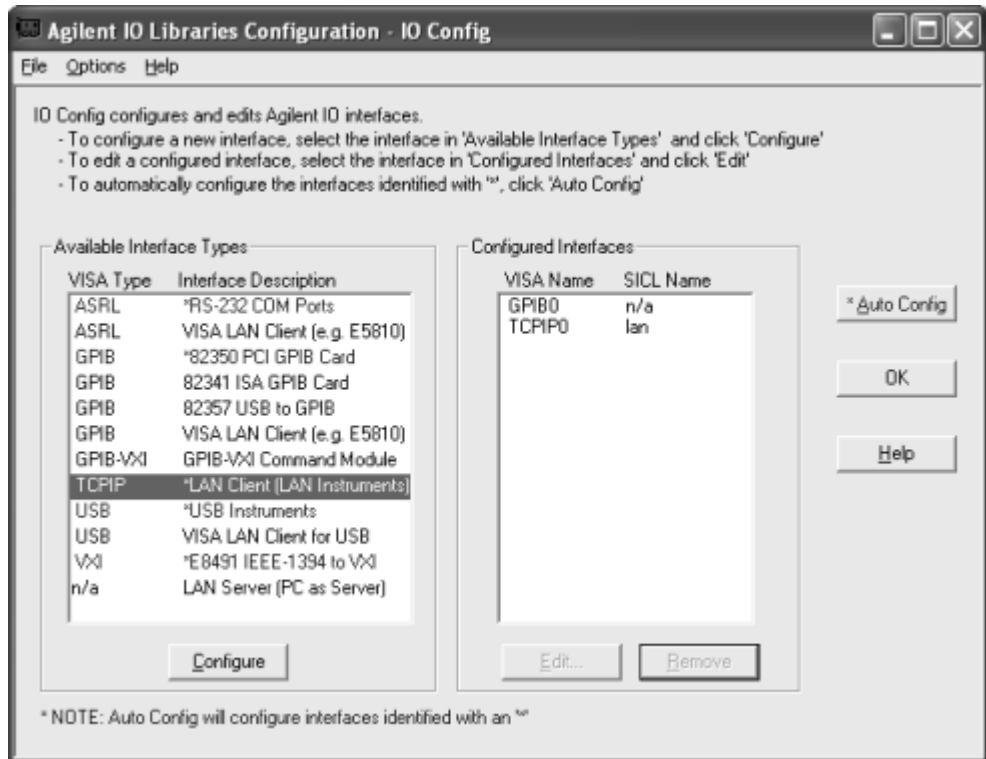

**NOTE**

After the system is configured, this screen may also display an **Edit VISA Config...** button. Clicking this button allows you to manually configure the interface as desired.

- When the **LAN Client** screen appears, set the **SICL Interface Name**, **VISA Interface Name**, **Logical Unit** number, **Server Timeout** value, and **Client Timeout Delta** as required. Also, you can select the **Default Protocol (AUTO, VXI-11, or SICL-LAN)** and choose whether or not to **Log Errors**. Then, click the **OK** button.

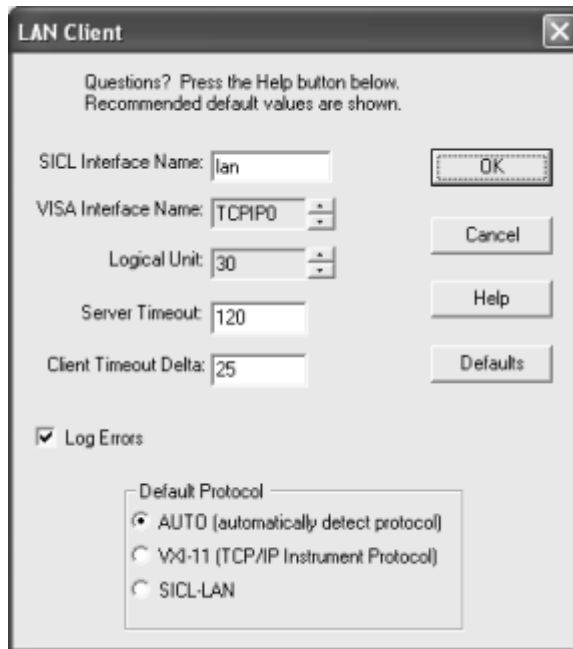

### Example: Configuring TCP/IP LAN Client (E5810 Gateway) Interface

The TCP/IP LAN Client interface system in the following figure consists of a Windows PC with a LAN card, an E5810 LAN/GPIB gateway, and two GPIB instruments. For this system, the IO Config utility has been used to assign the LAN card a VISA name of **TCPIP0** and SICL name of **lan**.

## 5 Configuring IO Interfaces

With these names assigned to the interface, VISA/SICL addressing is as shown in the figure. Since unique names have been assigned by IO Config, you can now use the VISA **viOpen** command or the SICL **iopen** command to open the IO paths to the GPIB instruments as shown in the figure.

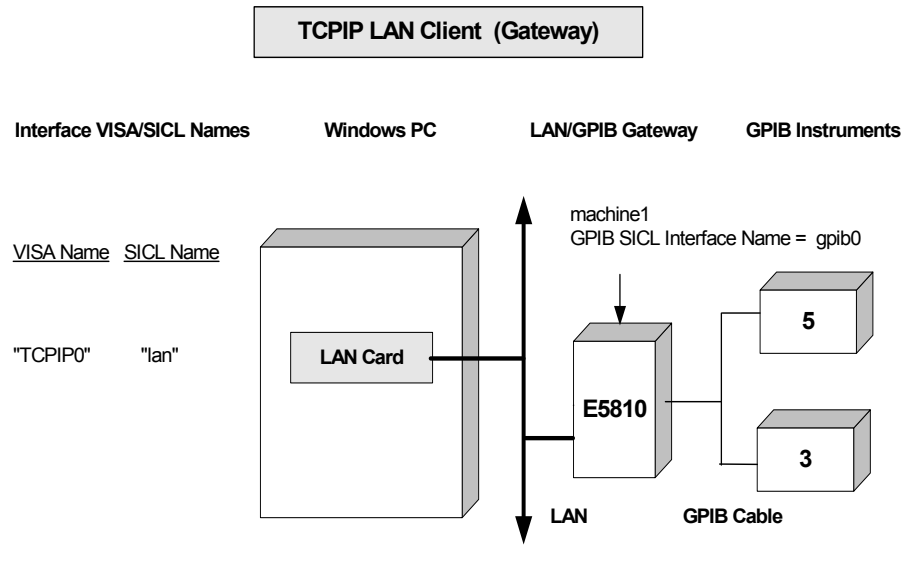

### VISA/SICL Addressing (Using LAN Client)

<p>VISA: viOpen (... "TCPIP0::machine1::gpib0,5::INSTR"...)   viOpen (... "TCPIP0::machine1::gpib0,3::INSTR"...)</p>	<p>Open IO path to GPIB instrument at address 5   Open IO path to GPIB instrument at address 3</p>
<p>SICL: iopen ("lan [machine1]:gpib0,5")   iopen ("lan [machine1]:gpib0,3")</p>	<p>Open IO path to GPIB instrument at address 5   Open IO path to GPIB instrument at address 3</p>

### Example: Configuring TCP/IP LAN Client (LAN Instruments) Interfaces

The TCP/IP LAN Client interface system in the following figure consists of a Windows PC with a LAN card and three LAN instruments. Instrument1 and instrument2 are VXI-11.2 (GPIB Emulation) instruments and instrument3 is a VXI-11.3 LAN instrument.

For this system, the IO Config utility has been used to assign the LAN card a VISA name of **TCPIP0** and SICL name of **lan**. For the addressing examples, instrument1 has been addressed by its machine name, instrument 2 has been addressed by its IP address, and instrument3 by its LAN name (**inst0**).

Since unique names have been assigned by IO Config, you can now use the VISA **viOpen** command or the SICL **iopen** command to open the IO paths to the GPIB instruments as shown in the figure.

## 5 Configuring IO Interfaces

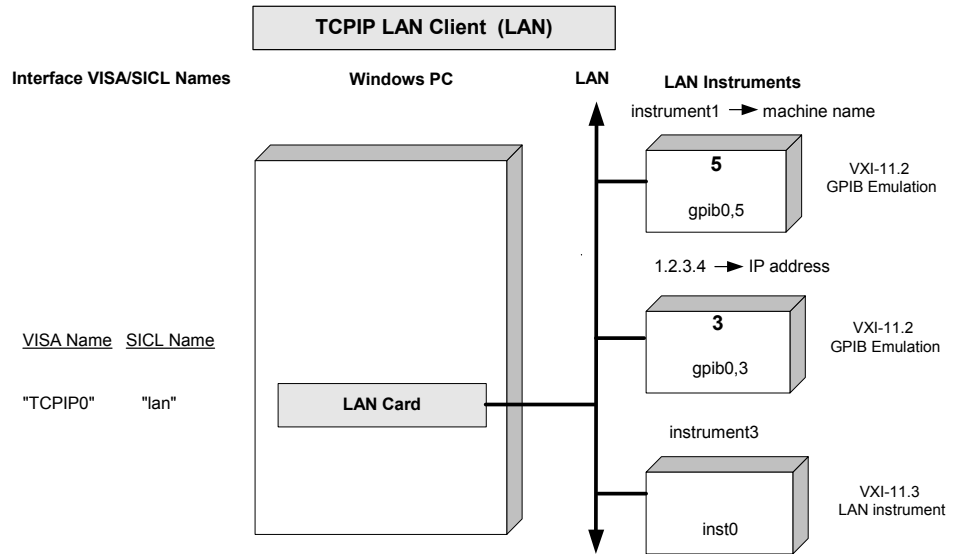

### VISA/SICL Addressing (Using LAN Client)

VISA: viOpen (... "TCPIP0::instrument1::gplib0,5::INSTR"...)  
 viOpen (... "TCPIP0::1.2.3.4::gplib0,3::INSTR"...)  
 viOpen (... "TCPIP0::instrument3::inst0::INSTR"...)

Open IO path to LAN instrument at address 5  
 Open IO path to LAN instrument at address 3  
 Open IO path to LAN instrument3

SICL: iopen ("lan [instrument1]:gplib0,5")  
 iopen ("lan [1.2.3.4]:gplib0,3")  
 iopen ("lan [instrument3]:inst0")

Open IO path to LAN instrument at address 5  
 Open IO path to LAN instrument at address 3  
 Open IO path to LAN instrument3

## Configuring GPIB VISA LAN Client Interfaces

### NOTE

When GPIB VISA LAN Client or ASRL VISA LAN Client is configured, the TCP/IP LAN Client interface is also automatically configured. See "Configuring TCP/IP LAN Client Interfaces" for details on configuring TCP/IP LAN Client interfaces.

**Using IO Config to Configure GPIB VISA LAN Client Interfaces** To configure GPIB VISA LAN Client interfaces using the IO Config utility:

- 1 Click the Agilent IO Libraries Control **IO** icon (blue icon on the Windows taskbar) and click **Run IO Config**. When the main screen appears, highlight the **GPIB VISA LAN Client (e.g. 5810)** menu item and then click the **Configure** button.

## NOTE

To configure an ASRL (RS-232) instrument for VISA LAN Client, see “Configuring ASRL VISA LAN Client Interfaces” in this chapter.

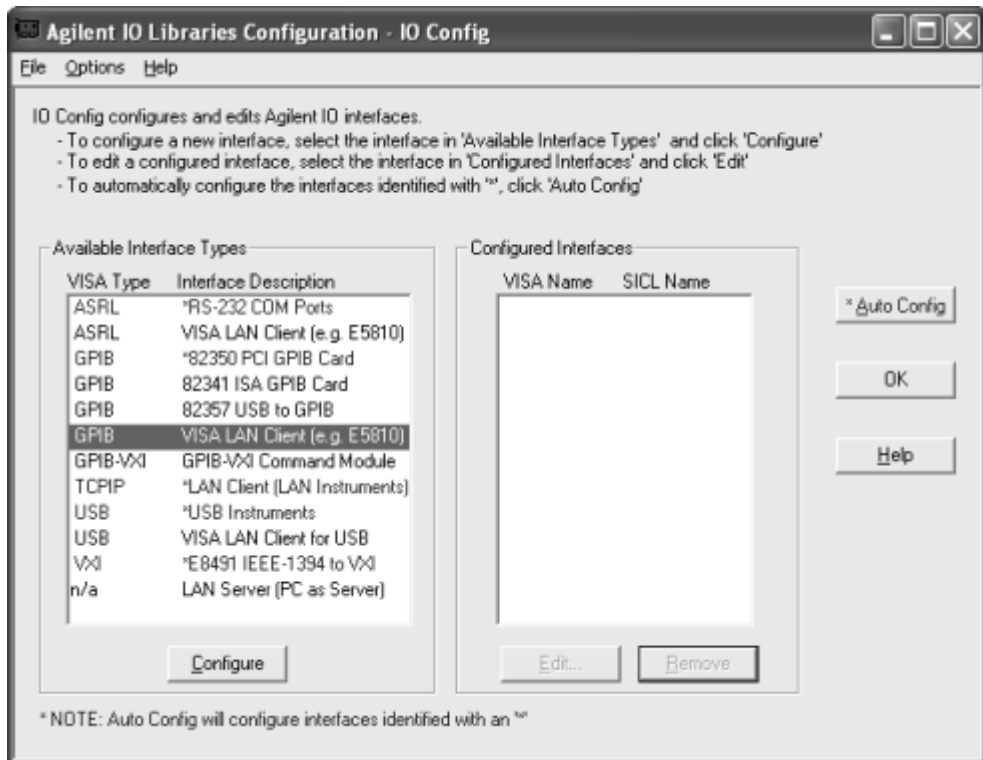

### NOTE

GPIB VISA LAN Client (e.g. E5810) is not marked with an asterisk (\*) (interface is not Autoconfigurable) because you cannot use the **\*Auto Config** button to automatically configure the interface. Instead, you must manually configure the interface, as shown.

- When the **VISA LAN Client Interface (LAN to GPIB)** screen appears, set the **Remote Hostname or IP Address** and **Remote SICL Interface Name** as shown in the following figure. Then, click the **OK** button. See *Chapter 3 - Using E5810 Web Access* in the *E5810 LAN/GPIB Gateway for Windows User's Guide* for information on using the E5810 Welcome page.

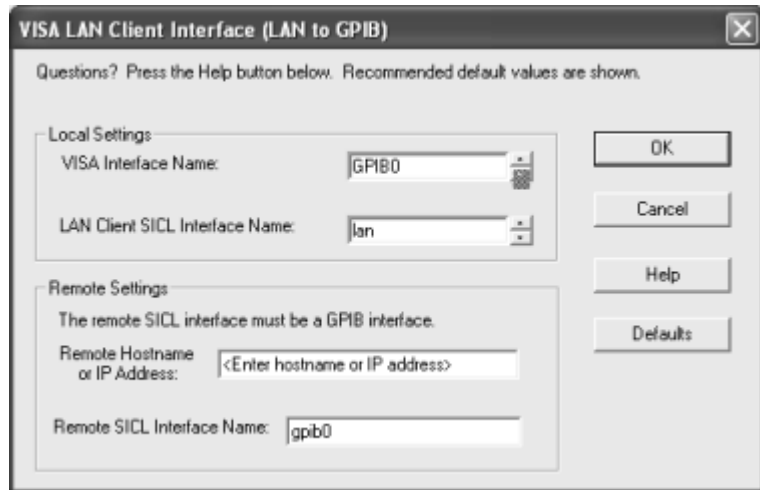

- Do Not Delete the LAN Client Interface.** When the VISA LAN Client is configured, the LAN Client is also automatically configured in the background. Thus, when VISA LAN Client configuration completes, two configured interfaces are displayed on the IO Config main screen. See the following figure for a typical display. Do NOT remove the



LAN Client or the VISA LAN Client interface, as the application does not run if either interface is removed.

VISA LAN Client (GPIB0) and LAN Client (TCPIP0) are both configured Interfaces. Do NOT remove either interface.

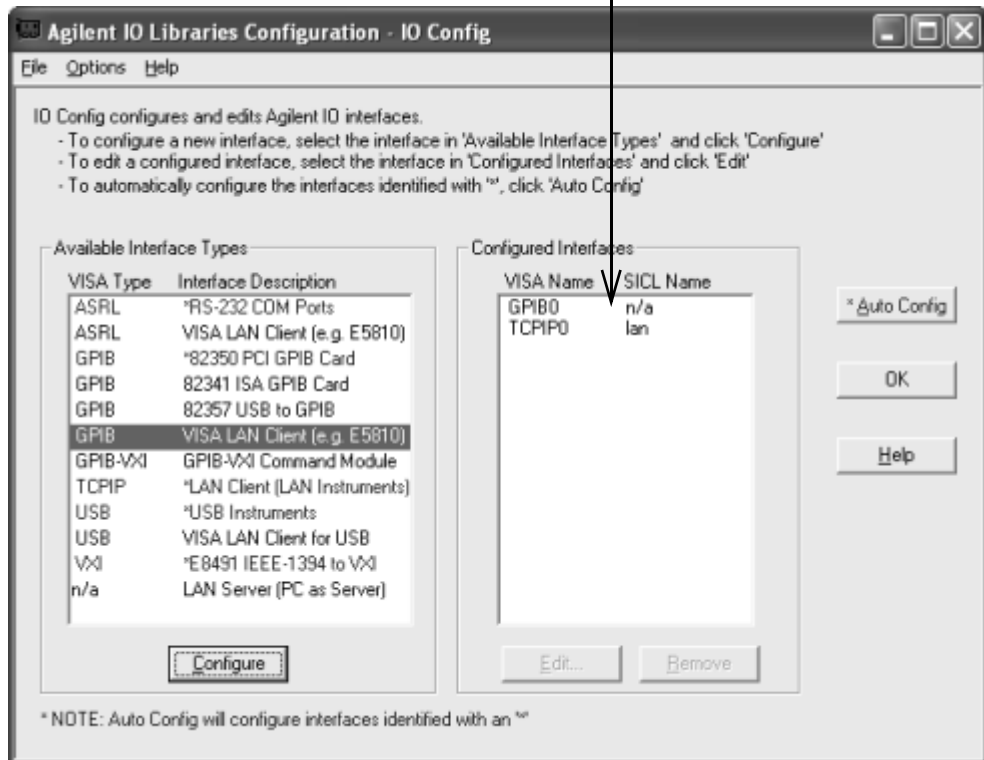

### Example: Configuring GPIB VISA LAN Client (E5810 Gateway) Interfaces

The GPIB VISA LAN Client interface system in the following figure consists of a Windows PC with a LAN card, an E5810 LAN/GPIB Gateway, and two GPIB instruments. The IO Config utility has been used to assign the values shown in the figure.

Since unique names have been assigned by IO Config, you can now use the VISA **viOpen** command or the SICL **iopen** command to open the IO paths to the GPIB instruments as shown in the figure. However, SICL addressing is *not* supported when using GPIB VISA LAN Client.

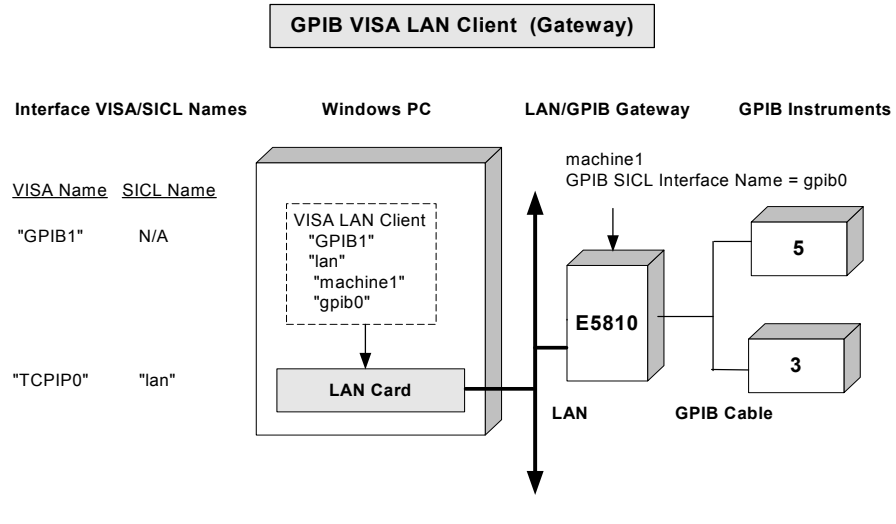

**VISA LAN Client Parameters**

VISA Interface Name	"GPIB1"
LAN Client SICL Interface Name	"lan"
Remote Host Name	"machine1"
Remote SICL Interface Name	"gpib0"

**VISA/SICL Addressing (Using LAN Client)**

VISA: viOpen (... "TCPIP0::machine1::gpib0,5::INSTR"...)	Open IO path to GPIB instrument at address 5
viOpen (... "TCPIP0::machine1::gpib0,3::INSTR "...)	Open IO path to GPIB instrument at address 3
SICL: iopen ("lan [machine1]:gpib0,5")	Open IO path to GPIB instrument at address 5
iopen ("lan [machine1]:gpib0,3")	Open IO path to GPIB instrument at address 3

**VISA Addressing (Using VISA LAN Client)**

VISA: viOpen (... "GPIB1::5::INSTR"...)	Open IO path to LAN instrument at address 5
viOpen (... "GPIB1::3::INSTR "...)	Open IO path to LAN instrument at address 3

### Example: Configuring GPIB VISA LAN Client (LAN Instruments) Interfaces

The GPIB VISA LAN Client interface system in the following figure consists of a Windows PC with a LAN card and three LAN instruments. Instrument1 and instrument2 are VXI-11.2 (GPIB Emulation) instruments and instrument3 is a VXI-11.3 LAN instrument.

For this system, the IO Config utility has been used to assign the LAN card a VISA name of **TCPIPO** and SICL name of **lan**. In addition, two VISA LAN Clients have been configured with the interface names and host names shown in the figure.

For the addressing examples, instrument1 has been addressed by its machine name, instrument 2 has been addressed by its IP address, and instrument3 by its LAN name (**inst0**).

Since unique names have been assigned by IO Config, you can now use the VISA **viOpen** command or the SICL **iopen** command to open the IO paths to the GPIB instruments as shown in the figure. Note, however, that you cannot talk to instrument3 with GPIB VISA LAN Client. You must use LAN Client (with VISA or SICL) to talk to instrument3, since instrument3 is not a remote gpib interface.

#### NOTE

When using the VXI-11 protocol with GPIB VISA LAN Client, the Remote SICL Interface Name must be of the form **gpibN** where N is 0 or a positive integer. This restriction does not apply to the SICL-LAN protocol.

## 5 Configuring IO Interfaces

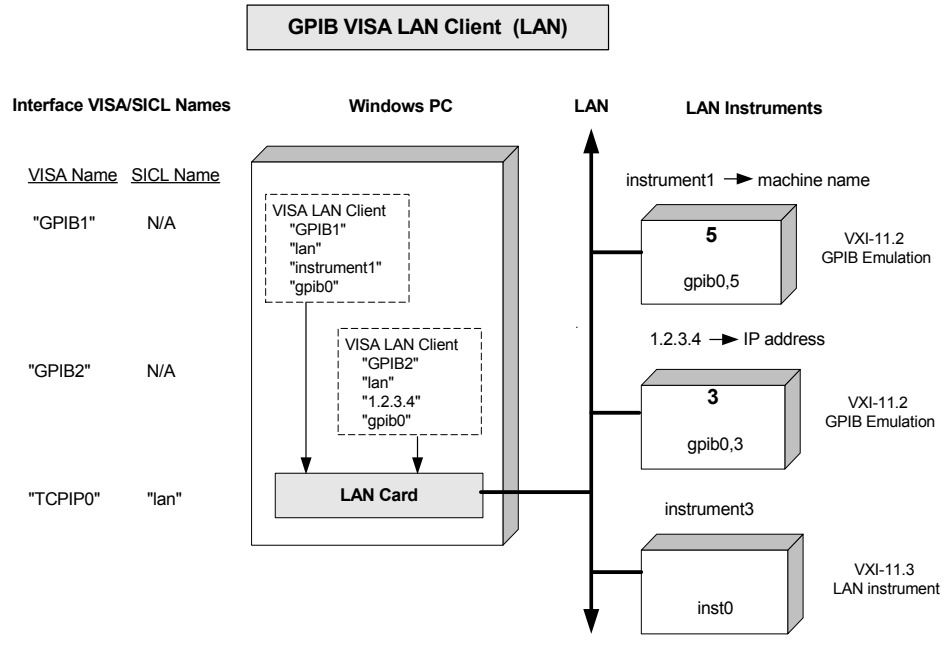

VISA LAN Client Parameters	GPIB1	GPIB2
VISA Interface Name	"GPIB1"	"GPIB2"
LAN Client SICL Interface Name	"lan"	"lan"
Remote Host Name	"instrument1"	"1.2.3.4"
Remote SICL Interface Name	"gpiB0"	"gpiB0"

### VISA/SICL Addressing (Using LAN Client)

VISA: viOpen (... "TCP/IP0::instrument1::gpiB0,5::INSTR"...)  
 viOpen (... "TCP/IP0::1.2.3.4::gpiB0,3::INSTR"...)  
 viOpen (... "TCP/IP0::instrument3::inst0::INSTR"...)

Open IO path to LAN instrument at address 5  
 Open IO path to LAN instrument at address 3  
 Open IO path to LAN instrument3

SICL: iopen ("lan [instrument1]:gpiB0,5")  
 iopen ("lan [1.2.3.4]:gpiB0,3")  
 iopen ("lan [instrument3]:inst0")

Open IO path to LAN instrument at address 5  
 Open IO path to LAN instrument at address 3  
 Open IO path to LAN instrument3

### VISA Addressing (Using VISA LAN Client)

VISA: viOpen (... "GPIB1::5::INSTR"...)  
 viOpen (... "GPIB2::3::INSTR"...)  
 Cannot talk to instrument3

Open IO path to LAN instrument at address 5  
 Open IO path to LAN instrument at address 3

### Configuring ASRL VISA LAN Client Interfaces

- 1 Click the Agilent IO Libraries Control **IO** icon (blue icon on the Windows taskbar) and click **Run IO Config** to display the IO Config utility main screen.
- 2 When the main screen appears, highlight the **ASRL VISA LAN Client** (e.g. E5810) menu item and click the **Configure** button to display the **VISA LAN Client Interface (LAN to ASRL)** screen.

#### NOTE

ASRL VISA LAN Client (e.g. E5810) is not marked with an asterisk (\*) (this interface is not Autoconfigurable) because you cannot use the **\*Auto Config** button to automatically configure the interface. Instead, you must manually configure the interface as shown.

---

## 5 Configuring IO Interfaces

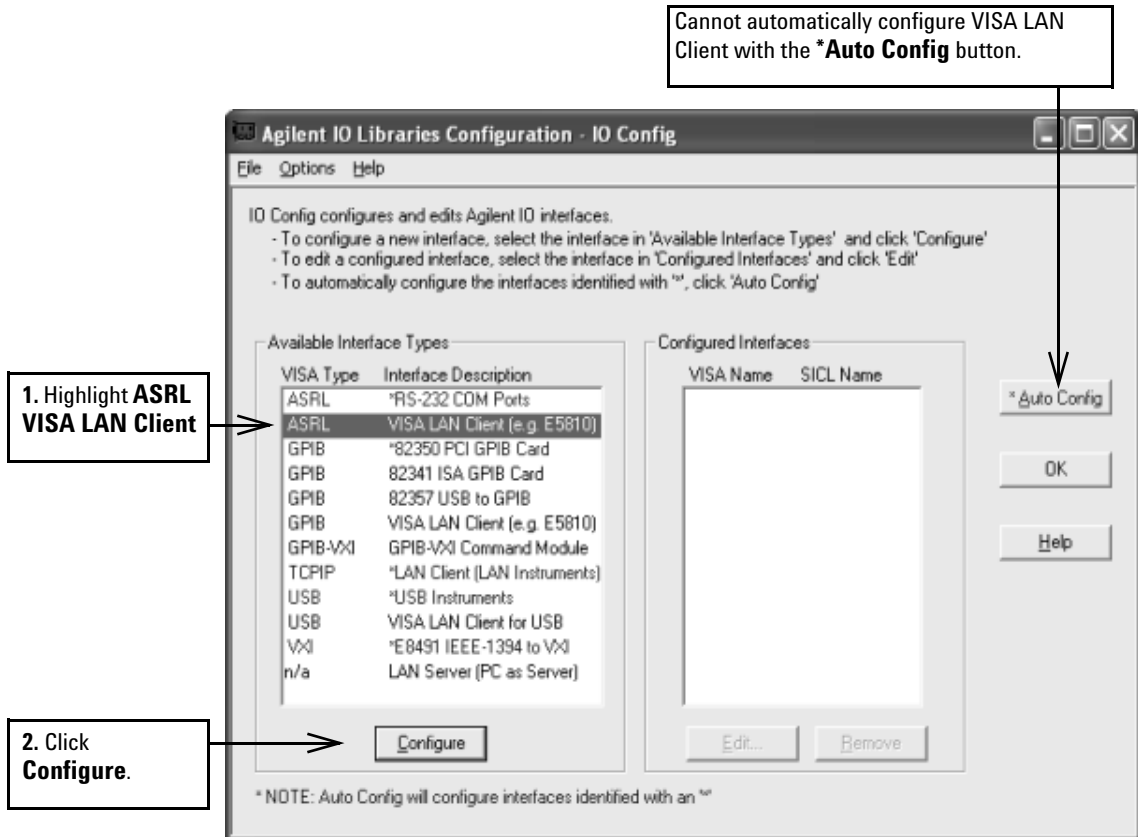

- 3 When the **VISA LAN Client Interface (LAN to ASRL)** screen appears, set the **Remote Hostname or IP Address** and **Remote SICL Interface Name** as shown in the following figure. Then, click the **OK** button. See *Chapter 3 - Using E5810 Web Access* in the *E5810 LAN/GPIB Gateway for Windows User's Guide* for information on using the E5810 Welcome page.

**NOTE**

After the system is configured, the VISA LAN Client Interface (LAN to ASRL) screen may also display an **Edit VISA Config...** button. Clicking this button allows you to manually configure the interface as desired. This optional feature is generally not required for the E5810.

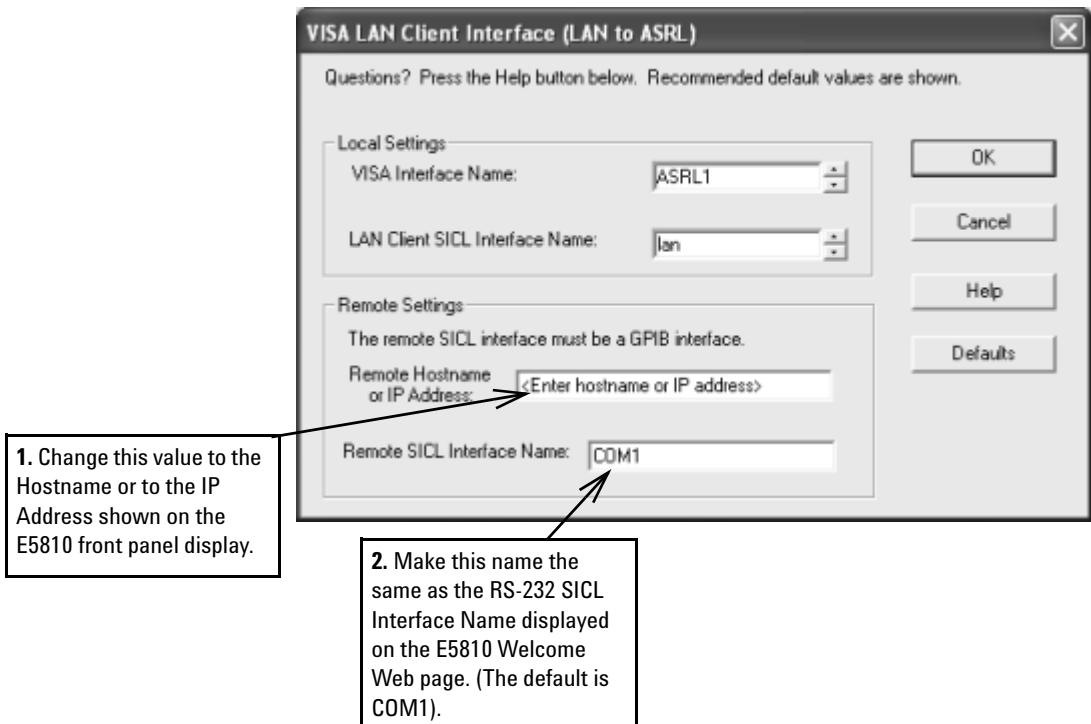

- 4 Do Not Delete the LAN Client Interface.** When the VISA LAN Client is configured, the LAN Client is also automatically configured in the background. Thus, when VISA LAN Client configuration completes, two configured interfaces are displayed on the IO Config main screen. See the following figure for a typical display. Do NOT remove the

## 5 Configuring IO Interfaces

LAN Client or the VISA LAN Client interface, as the application does not run if either interface is removed.

- 5 Using the VISA LAN Client (LAN to ASRL) requires the SICL-LAN protocol. This means that the LAN client default protocol must be set to either **AUTO** or **SICL-LAN** on the underlying LAN client that is being used.

VISA LAN Client (ASRL1) and LAN Client (TCPIP0) are both configured Interfaces. Do NOT remove either interface.

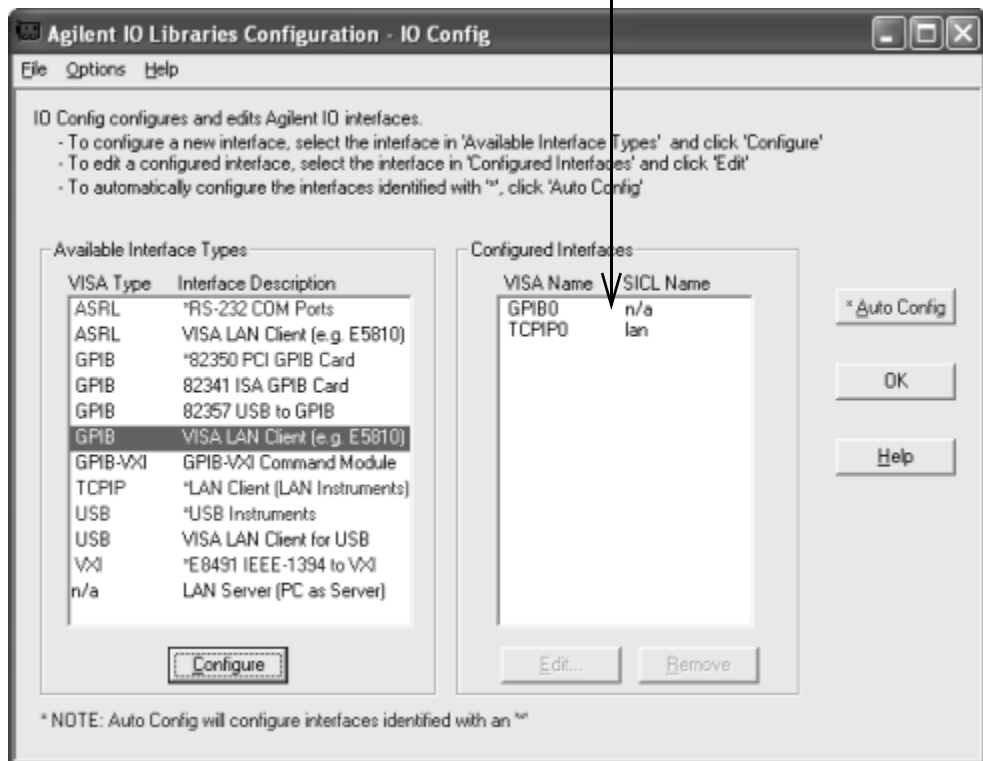



**Example: Configuring ASRL VISA LAN Client (E5810 Gateway) Interfaces**

The ASRL interface system in the following figure consists of a Windows PC with one RS-232 instrument connected via a LAN cable, an E5810 LAN/GPIB Gateway, and an RS-232 cable. Agilent assumes COM1 is the port used.

The IO Config utility has been used to assign COM port 1 a VISA name of **ASRL1** and SICL name of **COM1**. The E5810 has been assigned a Hostname of **machine1** and a GPIB SICL Interface Name of **COM1**.

## 5 Configuring IO Interfaces

Since unique names have been assigned by IO Config, you can now use the VISA **viOpen** command to open the IO paths to the RS-232 instrument as shown in the figure.

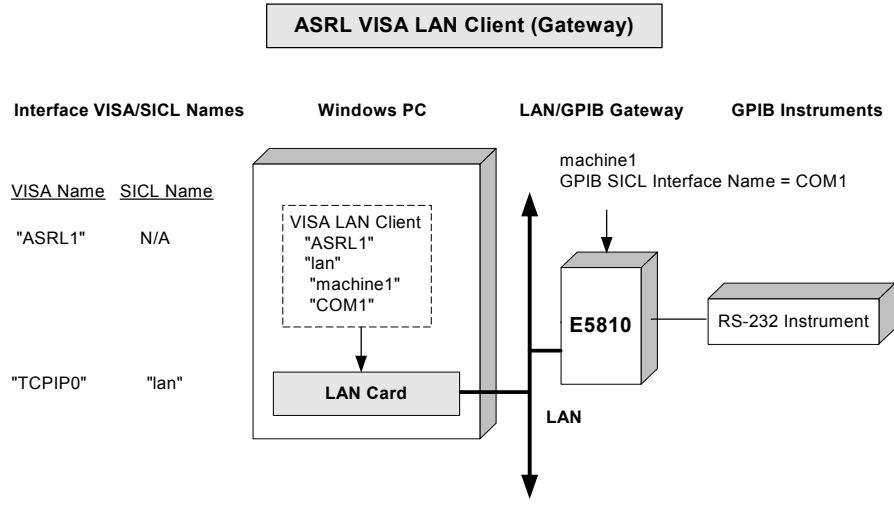

### VISA LAN Client Parameters

VISA Interface Name	"ASRL1"
LAN Client SICL Interface Name	"lan"
Remote Hostname	"machine1"
Remote SICL Interface Name	"COM1"

### VISA/SICL Addressing (Using LAN Client)

VISA: viOpen (... "TCPIP0::machine1::COM1, 488::INSTR"...)   
 SICL: iopen ("lan [machine1]:COM1,488")

Open I/O path to RS-232 instrument   
 Open I/O path to RS-232 instrument

### VISA Addressing (Using VISA LAN Client)

VISA: viOpen (... "ASRL1::INSTR"...)

Open I/O path to RS-232 instrument

### Configuring USB VISA LAN Client Interfaces

- 1 Click the Agilent IO Libraries Control **IO** icon (blue icon on the Windows taskbar) and click **Run IO Config** to display the IO Config utility main screen.
- 2 When the main screen appears, highlight the **USB VISA LAN Client for USB** menu item and click the **Configure** button to display the **USB LAN Client Interface (LAN to USB)** screen.

#### NOTE

USB VISA LAN Client for USB is not marked with an asterisk (\*) (this interface is not Autoconfigurable) because you cannot use the **\*Auto Config** button to automatically configure the interface. Instead, you must manually configure the interface as shown.

---

## 5 Configuring IO Interfaces

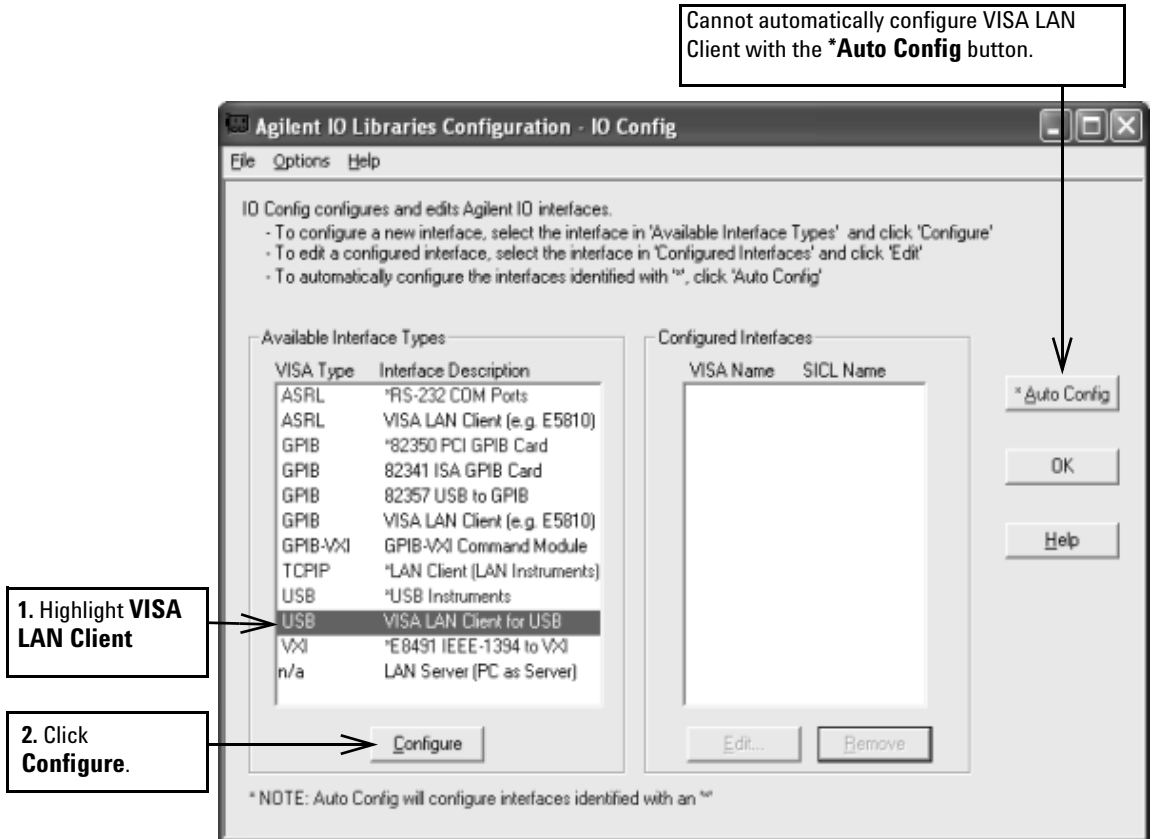

- 3 When the **VISA LAN Client Interface (LAN to USB)** screen appears, set the **Remote Hostname or IP Address** and **Remote SICL Interface Name** as shown in the following figure. Then, click the **OK** button.

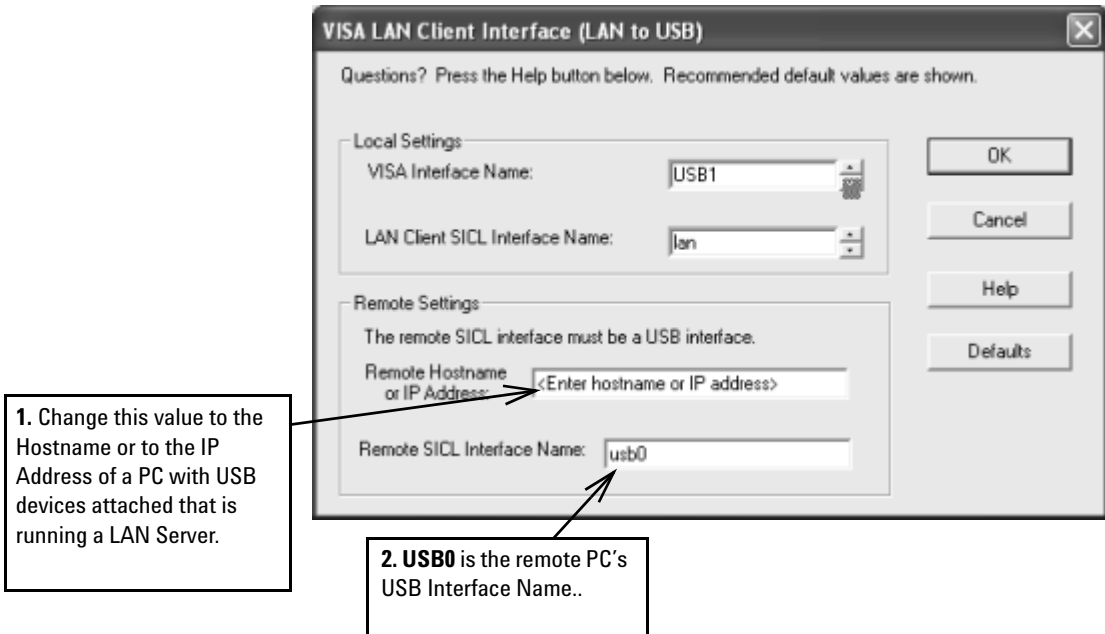

- 4 Do Not Delete the LAN Client Interface.** When the VISA LAN Client is configured, the LAN Client is also automatically configured in the background. Thus, when VISA LAN Client configuration completes, two configured interfaces are displayed on the IO Config main screen. See the following figure for a typical display. Do NOT remove the LAN Client or the VISA LAN Client interface, as the application does not run if either interface is removed.
- 5** Using the VISA LAN Client (LAN to USB) requires the SICL-LAN protocol. This means that the LAN client default protocol must be set to either **AUTO** or **SICL-LAN** on the underlying LAN client that is being used.

## 5 Configuring IO Interfaces

VISA LAN Client (USB1) and LAN Client (TCPIP0) are both configured Interfaces. Do NOT remove either interface.

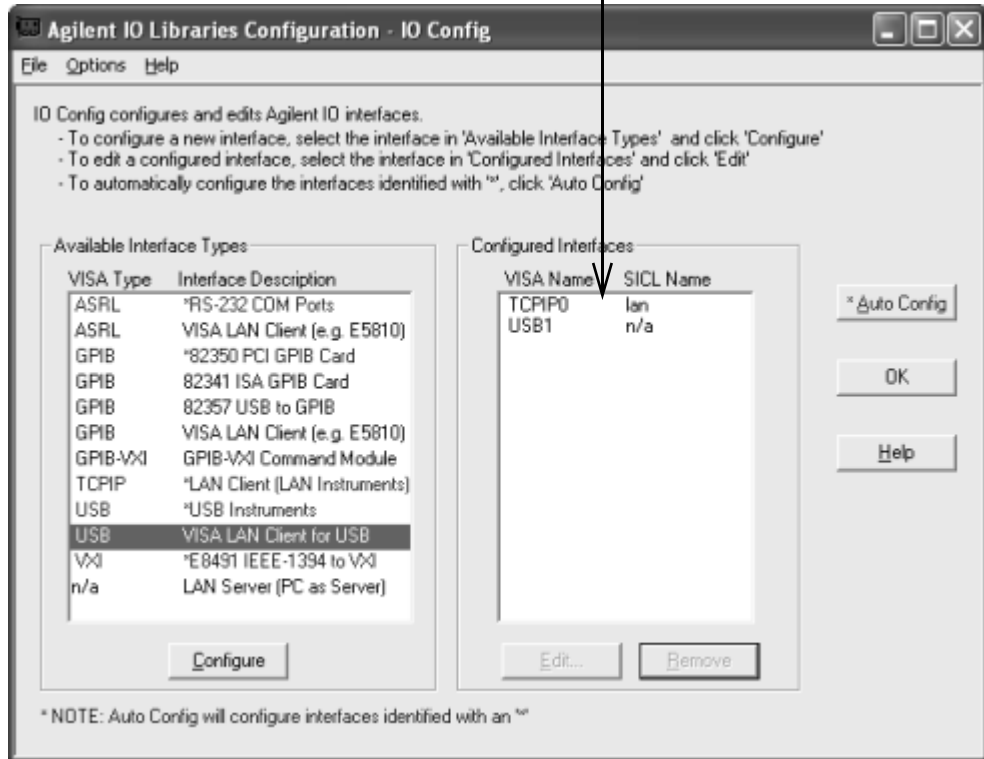

### Example: Configuring VISA LAN Client for USB Interfaces

The USB interface system in the following figure consists of a Windows PC with one USB instrument connected via a LAN cable to a remote PC with a USB device attached.

The USB VISA LAN Client has been used to configure a local VISA interface named **USB1** and SICL name of **usb1** to communicate with USB devices on a remote PC with a hostname of **machine1** and a remote SICL interface name of **usb0**.

Since unique names have been assigned by IO Config, you can now use the VISA **viOpen** command to open the IO paths to the USB instrument as shown in the figure.

## 5 Configuring IO Interfaces

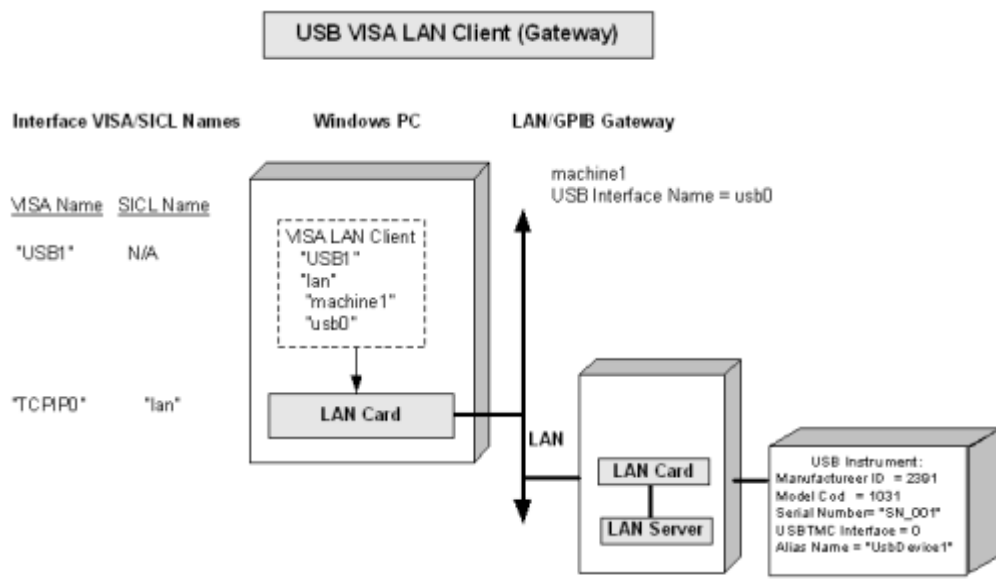

### VISA LAN Client Parameters

VISA Interface Name	"USB1"
LAN Client SICL Interface Name	"lan"
Remote Hostname	"machine1"
Remote SICL Interface Name	"usb0"

### VISA/SICL Addressing (Using LAN Client)

#### Using remote USB alias name:

VISA: `viOpen (... "TCP/IP0:machine1:UsbDevice1"...)`  
 SICL: `iopen ("lan [machine1]:UsbDevice1")`

Open I/O path to USB instrument  
 Open I/O path to USB instrument

#### Without using remote USB alias name:

VISA: `viOpen (... "TCP/IP0:machine1:usb0[2391::1031::SN_001::0]:INSTR"...)`  
 SICL: `iopen ("lan [machine1]:usb0[2391::1031::SN_001::0]")`

Open I/O path to USB instrument  
 Open I/O path to USB instrument

### VISA Addressing (Using VISA LAN Client)

#### Using remote USB alias name:

It is not possible to use the remote alias name with the VISA LAN Client.

#### Without using remote USB alias name:

VISA: `viOpen (... "USB1::2391::1031::SN_001::0:INSTR"...)`

Open I/O path to USB instrument

\*Note that you can use `viFindRsrc/viFindNext` to return the resource names of USB devices on the remote PC. You can then avoid having to code the device-specific resource string into your program.



## Configuring LAN Server Interfaces

### NOTE

The LAN Server supports both VXI-11 and SICL-LAN protocol. However, the LAN Server does not support simultaneous connections from LAN clients using the SICL-LAN Protocol and from LAN clients using VXI-11 (TCP/IP Instrument Protocol).

**Using IO Config to Configure LAN Server Interface** To configure LAN Server interfaces using the IO Config utility:

- 1 Click the Agilent IO Libraries Control **IO** icon (blue icon on the Windows taskbar) and click **Run IO Config**. When the main screen appears, highlight the **n/a LAN Server (PC as Server)** menu item and then click the **Configure** button.

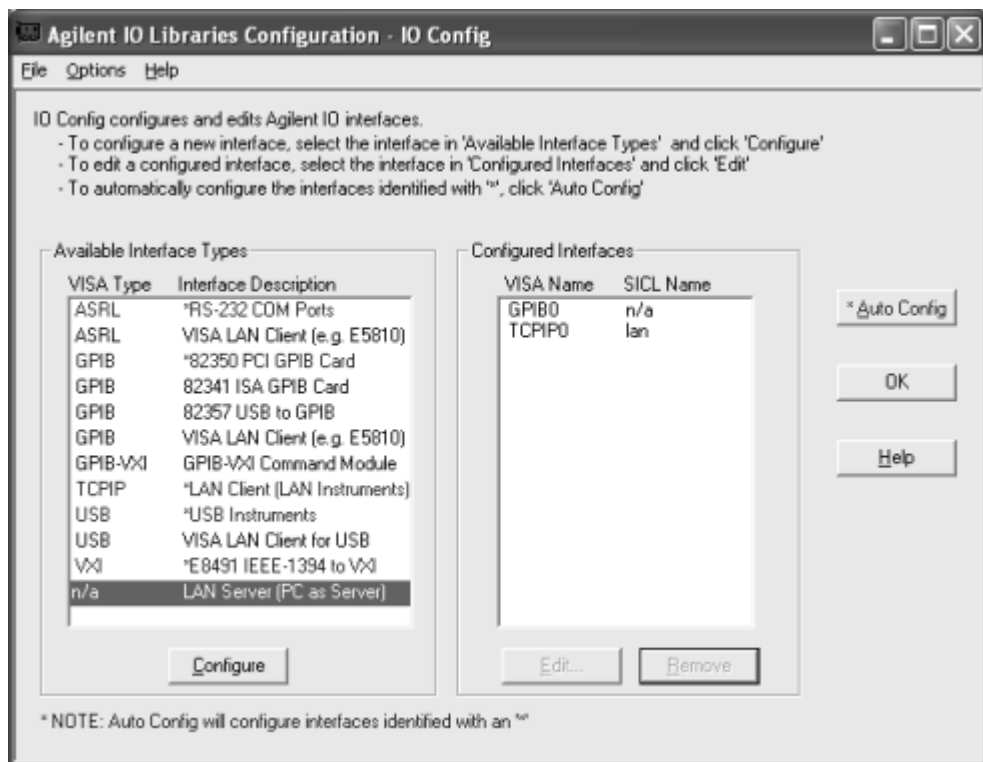

- 2 When the **Agilent LAN Server** screen appears, set the **Server Timeout** value as required. Also set **Log Errors**, **Log Locks and Connections** and/or **Use Keepalive Client Probes**. Then click **OK**.

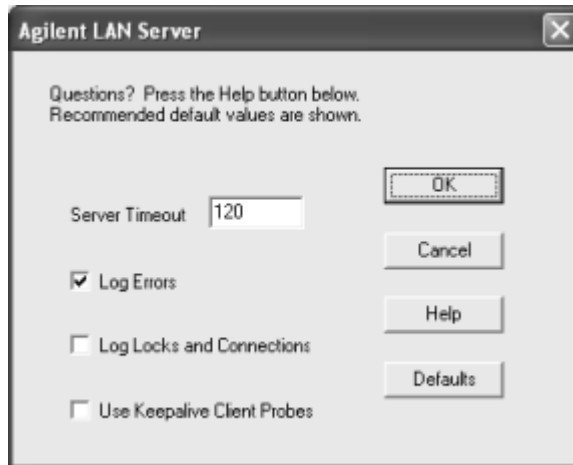

### Example: Configuring LAN Server (PC as Server) Interfaces

The LAN Server interface system in the following figure consists of a Windows PC acting as a LAN client, a second PC acting as a LAN server, and a GPIB instrument. The IO Config utility has been used to assign the LAN card a VISA name of **TCPIP0** and SICL name of **lan**.

Also, the GPIB card in the LAN server PC has been assigned VISA name of **GPIB0** and SICL name of **gpib0**. The LAN server PC has been assigned a name of **machine2**.

Since unique names have been assigned by IO Config, you can now use the VISA **viOpen** command or the SICL **iopen** command to open the IO paths to the GPIB instruments as shown in the figure.

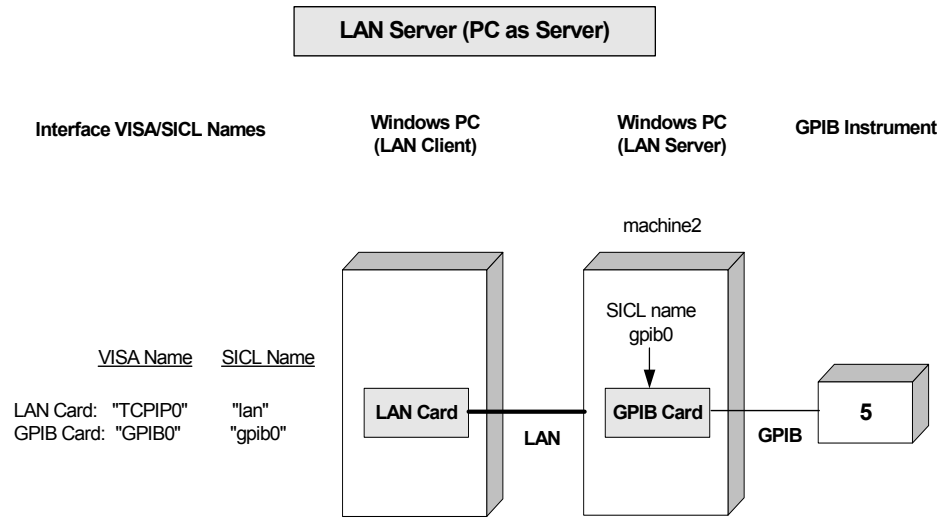

**VISA/SICL Addressing**

VISA: viOpen (... "TCPIP0::machine2::gplib0,5::INSTR".....)    Open IO path to GPIB instrument at address 5

SICL: iopen ("lan,[machine2]:gplib0, 5")    Open IO path to GPIB instrument at address 5

**Configuring ASRL Interfaces**

This section provides guidelines for using the IO Config utility to configure ASRL (RS-232) interfaces, including:

- ASRL Interfaces Overview
- Configuring ASRL (COM Ports) Interfaces

**NOTE**

To configure ASRL instruments via the LAN, see "Configuring ASRL VISA LAN Client Interfaces" in this chapter.

### ASRL Interface Overview

As shown in the following figure, a typical ASRL (RS-232) interface consists of a Windows PC with one or more RS-232 COM ports connected to RS-232 instruments. Each COM port can be connected to only one RS-232 instrument.

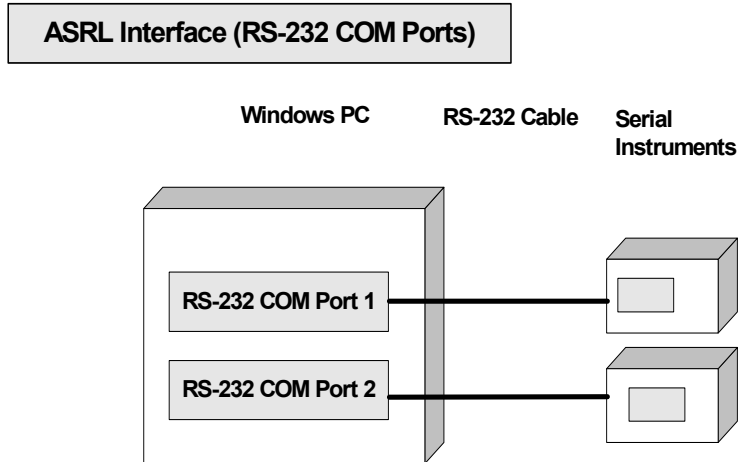

### Configuring ASRL (RS-232 COM Ports) Interfaces

#### Using IO Config to Configure ASRL (RS-232 COM Ports) Interfaces

To configure ASRL (RS-232 COM Ports) interfaces using the IO Config utility:

- 1 Click the Agilent IO Libraries Control **IO** icon (blue icon on the Windows taskbar) and click **Run IO Config**. When the main

screen appears, highlight the **ASRL RS-232 COM Ports** menu item and click the **Configure** button.

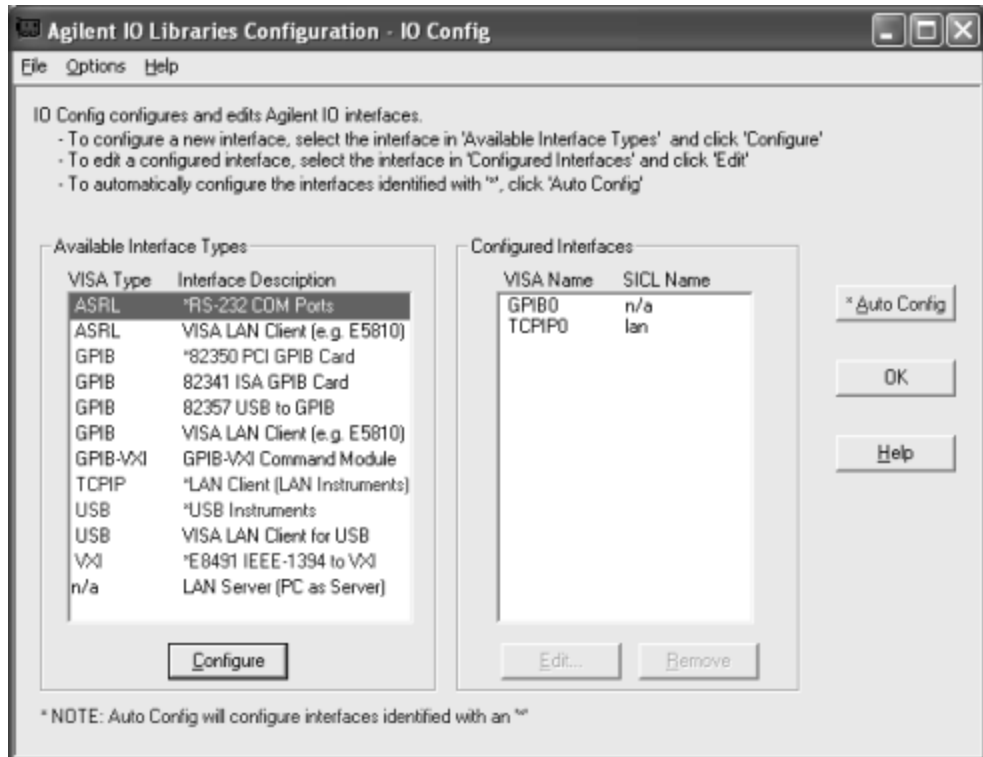

- 2 When the **Choose COM Port** screen appears, highlight the desired COM port (**COM1** or **COM2**) and click **OK**.

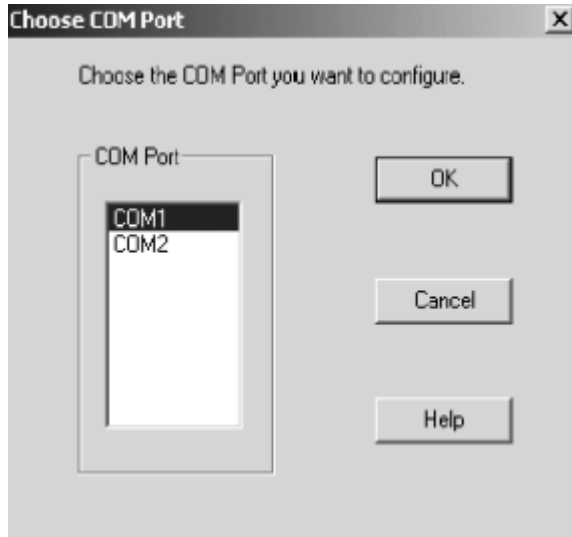

- 3 When the **RS-232 COM Ports** screen appears, set the **SICL Interface Name**, **VISA Interface Name**, and **Serial Port** attributes, and then click **OK**.

RS-232 COM Ports

Questions? Press the Help button below. Recommended default values are shown.

Port Number:  SICL Interface Name:

Logical Unit:  VISA Interface Name:

Stop Bits:  Baud Rate:

Data Size:  Parity:

SRQ Line:  Flow Control:

### Example: Configuring ASRL (RS-232 COM Ports) Interfaces

The ASRL interface system in the following figure consists of a Windows PC with two RS-232 COM ports, each of which is connected to a single Serial instrument via RS-232 cables.

The IO Config utility has been used to assign COM Port 1 a VISA name of **ASRL1** and SICL name of **COM1**. The IO Config utility has also been used to assign COM Port 2 a VISA name of **ASRL2** and SICL name of **COM2**.

Since unique names have been assigned by IO Config, you can now use the VISA **viOpen** command to open the IO paths to the Serial instruments as shown in the figure.

## 5 Configuring IO Interfaces

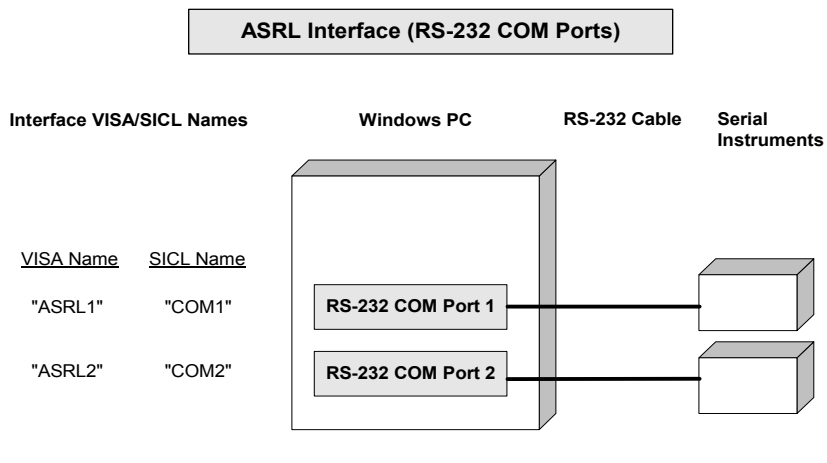

### VISA/SICL Addressing

VISA: viOpen (... "ASRL1::INSTR"...) viOpen (... "ASRL2::INSTR"...)	Open IO path to Serial instrument using COM Port 1 Open IO path to Serial instrument using COM Port 2
SICL: iopen ("COM1,488") iopen ("COM2,488")	Open IO path to Serial instrument using COM Port 1 Open IO path to Serial instrument using COM Port 2



# Index

## A

- Agilent IO Libraries
  - accessing previous versions, [112](#)
  - configuring ASRL interfaces, [203](#)
  - configuring ASRL VISA LAN Client interfaces, [189](#)
  - configuring GPIB interfaces, [141](#)
  - configuring GPIB ISA interfaces, [149](#)
  - configuring GPIB PCI interfaces, [146](#)
  - configuring GPIB VISA LAN Client interfaces, [182](#)
  - configuring GPIB-VXI (E1406A) interfaces, [154](#)
  - configuring LAN Server interfaces, [201](#)
  - configuring TCPIP LAN Client interfaces, [177](#)
  - configuring USB VISA LAN Client Interfaces, [195](#)
  - configuring USB/GPIB interfaces, [144](#)
  - configuring VXI (E8491) interfaces, [157](#)
  - installation type, selecting, [53](#)
  - IO Libraries Control icon, [102](#)
  - LAN Server, [137](#)
  - program groups created, [112](#)
  - supported interfaces, [116](#)
  - system requirements, [115](#)
  - VXI Resource Manager, [134](#)
- Agilent IO libraries
  - revisions, [118](#)
- Agilent IO Libraries, upgrading, [75](#)
- Agilent SIDL
  - description, [98](#)
  - related documentation, [99](#)
  - support, [98](#)
  - users, [99](#)
- Agilent VISA
  - description, [96](#)
  - related documentation, [97](#)
  - support, [97](#)
  - users, [97](#)

- ASRL interfaces
  - configuring, [203](#)
  - configuring RS-232 COM ports, [204](#)

## C

- client/server model, [173](#)
- Configuring ASRL VISA LAN Client Interfaces, [189](#)
- configuring GPIB interfaces, [141](#)

## E

- emergency repair disk, [13](#)
- examples
  - Configuring ASRL (RS-232 COM ports) Interfaces, [207](#)
  - Configuring ASRL VISA LAN Client (E5810) Interfaces, [193](#), [198](#)
  - Configuring GPIB ISA (82341) Interfaces, [151](#)
  - Configuring GPIB PCI (82350) Interfaces, [148](#)
  - Configuring GPIB VISA LAN Client (E5810) Interfaces, [185](#)
  - Configuring GPIB VISA LAN Client (LAN Instruments) Interfaces, [187](#)
  - Configuring GPIB-VXI (E1406A) Interfaces, [156](#)
  - Configuring LAN Server (PC as Server) Interfaces, [202](#)
  - Configuring TCPIP LAN Client (E5810) Interfaces, [179](#)
  - Configuring TCPIP LAN Client (LAN Instruments) Interfaces, [181](#)
  - Configuring USB/GPIB (82357) Interfaces, [145](#)
  - Configuring VXI (E8491B) Interfaces, [159](#)
  - Using IO Config, [127](#)
  - Using VISA Assistant, [130](#)

## G

- GPIB interfaces
  - configuring, [141](#)
  - configuring GPIB ISA interfaces, [149](#)
  - configuring GPIB PCI interfaces, [146](#)
  - configuring USB/GPIB interfaces, [144](#)

## I

- I/O interface configuration, [140](#)
- installation type, [53](#)
- interface name, [140](#)
- IO Config
  - requirements, [123](#)
  - running, [124](#)
- IP address, [181](#)

## L

- LAN Client interfaces, [177](#)
- LAN interfaces
  - client/server model, [173](#)
  - configuring LAN Server interfaces, [201](#)
  - configuring USB VISA LAN Client Interfaces, [195](#)
  - GPIB VISA LAN Client interfaces, [182](#)
  - hardware architecture, [173](#)
  - LAN Client interfaces, [177](#)
  - SIDL-LAN protocol, [175](#)
  - software architecture, [174](#)
  - TCP/IP protocol, [175](#)
  - VXI-11 protocol, [175](#)
- LAN Server, [137](#)
- LAN Server, using, [101](#)
- logical unit number, [140](#)

## P

- previous versions, accessing, [112](#)
- program groups created, [112](#)

## Index

### R

running IO Config, [124](#)

### S

SICL-LAN protocol, [175](#)  
supported interfaces, [116](#)  
system requirements, [115](#)

### T

TCP/IP instrument protocol, [175](#)  
TCPIP LAN Client interfaces, [177](#)

### U

upgrading Agilent IO Libraries, [75](#)

#### USB

- automatic configuration of devices, [161](#)
- configuring interfaces, [161](#)
- editing device alias names, [163](#)
- ensuring Windows XP SP1 USB Drivers are installed, [169](#)
- ensuring Windows XP SP1 USB drivers are installed, [169](#)
- troubleshooting device configurations, [167](#)
- updating drivers, [171](#)

### V

VISA Assistant  
using, [129](#)

VXI interfaces  
configuring GPIB-VXI interfaces, [154](#)  
configuring VXI interfaces, [157](#)

VXI Resource Manager, using, [134](#)

VXI-11 protocol, [175](#)